

# Tubing



Making 50' spools of Upchurch Scientific® FEP tubing in Oak Harbor, WA.



**NEW!**

The tubing chapter now includes a wide variety of peristaltic pump tubing for Ismatec® peristaltic pumps

## Dear Customer

We are pleased to present our 2011/2012 catalog, which includes Innovadyne™, Ismatec®, Isolation Technologies™, Rheodyne®, Systemc®, and Upchurch Scientific® products. In this catalog, you will find all the critical fluidic products and high-quality components you've come to expect from IDEX Health & Science.

This catalog has a new 'look and feel', with a new organization to all of our products. Now, you will be able to find all of our fittings in one chapter, with separate chapters for products like tubing, valves, pumps, etc. And, as always, we have many new products – including some very innovative UHPLC fittings and accessories – scattered throughout the catalog that we hope will prove useful to you.

We appreciate your business and continued loyalty to our family of products and services and thank you for trusting IDEX Health & Science with your liquid handling needs. Your feedback is valuable, so please let us know if there are ways we can be of greater service.



**Joe Stupfel**

VP Marketing & Research, Development & Engineering  
IDEX Health & Science LLC

## IDEX Health & Science Contact Information

### NORTH / SOUTH AMERICA

#### **IDEX Health & Science LLC**

619 Oak Street  
Oak Harbor, WA 98277 USA  
Tel: +1 800 426 0191  
Fax: +1 800 359 3460  
Fax: +1 360 679 3830  
E-mail: CustomerService.hs@idexcorp.com

### EUROPE

#### **IDEX Health & Science GmbH**

Futtererstrasse 16  
97877 Wertheim  
Germany  
Tel: +49 (0) 1801 808 800  
Fax: +49 (0) 9377 1388  
E-mail: CustomerService.hseurope@idexcorp.com

### ASIA

#### **IDEX Trading (Shanghai) Co. Ltd**

Room 1701A  
CBD International Plaza  
No. 16 Yong An Dong Li  
Beijing, China 100022  
Tel: +86 10 6566 9090  
Fax: +86 10 6567 5152  
E-mail: CustomerService.hsasia@idexcorp.com

#### **IDEX Asia Pacific Pte Ltd**

63 Hillview Avenue #07-08  
Lam Soon Industrial Building  
Singapore 669569  
Tel: +65 6314 6145  
Fax: +65 6764 4020  
E-mail: CustomerService.hsasia@idexcorp.com

#### **IDEX India Pvt Ltd**

205, Matharu Arcade  
Plot No. 32 Subhash Road  
Vile Parle (East)  
Mumbai – 400 057 India  
Tel: +91 22 66 78 00 50  
Fax: +91 22 66 78 00 55  
E-mail: CustomerService.hsasia@idexcorp.com

#### **IDEX Health & Science**

6F Sanseido Bldg.  
2-4 Kojimachi, Chiyoda-ku,  
Tokyo 102-0083, Japan  
Tel: +81 3 3263 5390  
Fax: +81 3 3511 5890  
E-mail: CustomerService.hsasia@idexcorp.com

## How to Order

### Direct from IDEX Health & Science

#### For North America orders:

**Tel:** +1 800 426 0191 ▶ +1 360 679 2528  
**Fax:** +1 800 359 3460 ▶ +1 360 679 3830  
**E-mail:** CustomerService.hs@idexcorp.com

#### For Europe orders:

**Tel:** +49 (0) 1801 808 800  
**Fax:** +49 (0) 9377 1388  
**E-mail:** CustomerService.hseurope@idexcorp.com

#### For Asia orders:

**E-mail:** CustomerService.hsasia@idexcorp.com

##### NORTH ASIA

**Tel:** +86 10 6566 9090  
**Fax:** +86 10 6567 5152

##### SOUTH AND SOUTHEAST ASIA

**Tel:** +91 22 66 78 00 50  
**Fax:** +91 22 66 78 00 55

##### JAPAN

**Tel:** +81 3 3263 5390  
**Fax:** +81 3 3511 5890

#### For Online orders:

**Web:** www.idex-hs.com

Please include the following information with your order: Purchase Order Number, Contact Name, Shipping and Billing Address, Telephone Number, Product Number(s) and Quantity(ies). If you are a Purchasing Agent, please include the name of the person for whom the products are ordered.

For your information, our Federal Taxpayer Identification number is 01-0736657.

### Order Processing/Shipping

Orders process within one business day and ship within two business days. Requests for earlier shipments can be made — please contact IDEX Health & Science for more details.

All shipments are FCA unless otherwise noted. Shipping charges will be prepaid and added to the invoice. Or, if requested, we will charge your carrier account number.

### Terms



Terms of payment are net 30 days. Mastercard®, Visa® and American Express® are accepted.

There is no minimum order. Customers are responsible for C.O.D. charges if they elect this payment method. Terms and prices are subject to change without notice. Visit [www.idex-hs.com](http://www.idex-hs.com) for complete Terms & Conditions.

### Return of Materials

Returns must be authorized in advance. Please contact us within 30 days of purchase for your Returns Material Authorization (RMA) Number. A restocking fee may apply.

### Direct from our Global Distribution Network

The IDEX Health & Science brands represented in this catalog (Innovadyne™, Ismatec®, Isolation Technologies™, Rheodyne®, Systec®, and Upchurch Scientific®) have established relationships with a large, global network of Distributors, many of whom can offer the product support and assistance that we cannot, including:

- ▶ Carrying local inventory of commonly-ordered items
- ▶ Understanding YOUR working environment and requirements
- ▶ Providing technical application assistance
- ▶ Answering questions regarding new and existing products
- ▶ Complete availability during your time zone business hours
- ▶ Personal visits as required
- ▶ Access to complementary product lines to provide a “one-stop shopping” experience

We have come to rely on our authorized Distributors to provide value-added service to end-users of our products. So, while we are happy to take your order directly, we encourage you to contact your local Distributor — we feel confident it will be a positive experience!

### How to Find A Local Distributor

For a complete distributor listing please visit [www.idex-hs.com/distributors](http://www.idex-hs.com/distributors) or email:

**US:** CustomerService.hs@idexcorp.com

**Europe:** CustomerService.hseurope@idexcorp.com

**Asia:** CustomerService.hsasia@idexcorp.com

Our customer service team will help you contact a distributor in your area.

### Return of Materials

Product purchased through a Distributor must be returned directly to that Distributor. Please contact them for Return Material Authorization procedures.

Visit Us At  [WWW.IDEX-HS.COM](http://WWW.IDEX-HS.COM)

*The products in this catalog are intended for use with analytical, biotechnology and diagnostic equipment and accessories. THE MANUFACTURERS OF THE PRODUCTS IN THIS CATALOG SHALL HAVE NO LIABILITY WHATSOEVER DUE TO ANY MISUSE OF THEIR PRODUCTS. Of course, the safe use of our products depends on our customers, since it is you who select and control the protective gear and safety procedures used, as well as the pressures, temperatures, solvents, samples, ventilation, and other variables. Product and material performance ratings are provided as guides only. Individual field tests should be performed by customers to determine safe operating parameters given your particular procedures and use.*

IDEX Health & Science facilities are certified ISO 9001. Some facilities are also certified ISO 13485:2003.

TUBING	PEEK™	CAPILLARY PEEK	FUSED SILICA	PEEKsil™	SPIRAL-LINK™	RADEL®	STAINLESS STEEL
Page	64	65	65	66	67	67	68
<b>Description</b>	<p>Biocompatible, chemically inert to most commonly used solvents, PEEK tubing is flexible, offers a very smooth internal surface and can be easily cut to desired lengths.</p> <ul style="list-style-type: none"> <li>Great alternative for stainless steel tubing in high pressure applications</li> <li>Many sizes available in color scheme to help identify ID</li> </ul>	<p>All the benefits of larger sized PEEK tubing, while serving as an excellent alternative to more traditional fused silica and stainless steel capillary tubing, capillary PEEK tubing is available in a wide range of micro and nano-scale inner diameters.</p> <ul style="list-style-type: none"> <li>Available in common capillary tubing sizes with tight tolerances on OD and ID</li> <li>Tubing sleeves available for capillary tubing connections</li> </ul>	<p>Because of the tight tolerances of fused silica's inner diameters, this tubing is used for micro-scale analyses such as micro and nano-HPLC and capillary electrophoresis.</p> <ul style="list-style-type: none"> <li>Most commonly used OD and ID sizes available</li> <li>High quality, polyimide-clad fused silica</li> <li>Offered in convenient, two meter lengths</li> </ul>	<p>PEEKsil is mechanically strong and has ideal characteristics for sealing with metal or polymer fittings.</p> <ul style="list-style-type: none"> <li>Comprised of high quality fused silica sheathed by PEEK tubing</li> <li>Excellent chemical compatibility</li> <li>Very tight manufacturing tolerances</li> <li>Good replacement for stainless steel, PEEK or standard fused silica</li> </ul>	<p>The PEEK Spiral Link coils expand and contract, allowing you to easily move your system components or even make equipment repairs whenever needed, without the hassle of breaking connections.</p> <ul style="list-style-type: none"> <li>Available in several specific volumes</li> <li>Includes two SealTight™ fittings</li> </ul>	<p>A mechanically strong and chemically resistant material, much like PEEK polymer, Radel is frequently used in medical applications where repeated autoclave sterilization is performed (tests show product stability after 1,000 cycles). Radel tubing is also transparent, allowing technicians to visually monitor flow through their instrument. Readily wetted surfaces help keep air bubbles from accumulating on inner surfaces as well.</p> <ul style="list-style-type: none"> <li>Withstands up to 12,500 psi (862 bar)</li> <li>Transparent and autoclavable</li> </ul>	<p>Seamless, pre-cut 316 stainless steel tubing meets the exacting requirements of today's analyses. Thorough preparation guarantees that the tubing is truly ready-to-use, with flat-burr-free ends and a clean finish.</p> <ul style="list-style-type: none"> <li>Wide selection of outside and inside diameters and lengths</li> <li>Pre-cut to ensure burr-free, flat connections</li> <li>Many sizes feature a color-coded band for easy ID identification</li> </ul>
<b>Specifications</b>							
<b>OD (outside diameter)</b>	1/16" (1.6 mm), 0.071" (1.8 mm), 0.079" (2.0 mm), 1/8" (3.2 mm)	0.0145" (360 μm), 1/32" (785 μm), 0.020" (0.5 mm)	0.0145" (360 μm)	0.0145" (360 μm), 1/32" (785 μm), 1/16" (1.6 mm)	1/16" (1.6 mm)	1/16" (1.6 mm), 1/8" (3.2 mm)	0.020" (510 μm), 1/32" (785 μm), 1/16" (1.6 mm), 1/8" (3.2 mm)
<b>ID (inside diameter)</b>	0.001" (25 μm) – 0.080" (2.0 mm)	0.001" (25 μm) – 0.020" (0.50 mm)	0.0008" (20 μm) – 0.006" (150 μm)	0.001" (25 μm) – 0.012" (300 μm)	0.005" (125 μm) – 0.030" (0.75 mm)	0.010" (0.25 mm) – 0.062" (1.55 mm)	0.004" (100 μm) – 0.080" (2.0 mm)
<b>Operating Temp</b>	-51 to 100 °C	-51 to 100 °C	-51 to 100 °C	-51 to 100 °C	-51 to 100 °C	-51 to 100 °C	-51 to 289 °C
<b>Pressure Rating</b>	500 – 10,000 psi (34 – 690 bar)	2,000 – 5,000 psi (138 – 345 bar)	N/A*	10,000 psi (690 bar)	7,000 psi (484 bar)	5,500 – 12,500 psi (379 – 862 bar)	N/A*
<b>Typical Tolerances</b>	±0.001" (25 μm) for 1/16" OD tubing, ±0.003" (75 μm) for 1/8" OD tubing	±0.0005" (12.5 μm)	±0.0004" (10 μm)	±0.0004" (10 μm)	±0.001" (25 μm) for 1/16" OD tubing	±0.001" (25 μm) for 1/16" OD tubing, ±0.003" (75 μm) for 1/8" OD tubing	±0.001" (25 μm) for 1/16" OD tubing, ±0.003" (75 μm) for 1/8" OD tubing
<b>Refractive Index (Clarity)</b>	Opaque	Opaque	1.78	Opaque	Opaque	1.672	Opaque
<b>pH Range</b>	0 – 14	0 – 14	0 – 10	0 – 10	0 – 14	1 – 14	1 – 14
<b>Sterilization Techniques</b>	gamma irradiation; ethylene oxide; thermal	gamma irradiation; ethylene oxide; thermal	ethylene oxide; thermal	ethylene oxide; thermal	gamma irradiation; ethylene oxide; thermal	thermal, gamma irradiation	gamma irradiation; ethylene oxide; thermal
<b>Autoclavable?</b>	Y	Y	Y	Y	Y	Y	Y

\*The manufacturer of this tubing or material does not publish this specification.

## Upchurch Scientific® Tubing OD Sizes

Please use this table as a reference tool to help quickly locate within this chapter the appropriate OD size tubing for your application.

Size	Tubing OD	Page(s)
•	360 μm	65, 66, 72
•	510 μm	65
•	1/32"	65, 66, 69, 71
•	1/16"	64, 66, 67, 69, 71, 72, 73, 78, 79
•	1/8"	64, 67, 69, 71, 72, 73, 78,
•	3/16"	71, 72
•	1/4"	72, 73, 78

Size	Tubing OD	Page(s)
•	5/16"	71
•	1 mm	71
•	1.8 mm	64
•	2 mm	64, 69, 71
•	3 mm	71
•	4 mm	71, 85, 86, 87, 88

## PEEK™ Tubing

- ▶ 1/16", 1/8", 1.8 mm or 2.0 mm outside diameter available
- ▶ Biocompatible, inert and easily cut
- ▶ Great for high pressure applications
- ▶ Maximum continuous use temperature: 100 °C

Upchurch Scientific® PEEK (polyetheretherketone) polymer tubing is biocompatible, chemically inert to most solvents, and can be used to replace stainless steel tubing in most liquid analytical systems. Unlike stainless steel and titanium tubing, PEEK tubing is flexible and can be easily cut to desired lengths. PEEK tubing can be used with stainless steel or polymer fittings.

PEEK tubing has a very smooth internal surface, which causes less turbulence than similar sized metal tubing, contributing to improved resolution of sample bands. Of all our polymer tubing materials, PEEK is the least permeable to gas (see material properties on our website: [www.idex-hs.com](http://www.idex-hs.com)).

In addition, much of our 1/16" OD tubing is color-coded so different IDs are easily identified. Our proprietary extrusion process ensures color permanence in our tubing.

PEEK tubing offers outstanding chemical compatibility, with very few solvents interacting with the polymer. For information regarding specific solvents that may interact with the polymer, please visit [www.idex-hs.com](http://www.idex-hs.com) or contact IDEX Health & Science or your local Distributor.

Our 5' length tubing is rough cut to approximately 5'1". A trim cut should be made before use, especially for smaller ID tubing. PEEK tubing can be cut easily with a razor blade. However for an improved cut, try our Tubing Cutters on page 74.



## Specifications

Tubing OD	OD Tolerance	Tubing ID	ID Tolerance
1/16"	±0.001" (25 µm)	25 µm	±0.0005" (12.5 µm)
1/16"	±0.001" (25 µm)	All (except 25 µm)	±0.001" (25 µm)
1.8 mm	±0.002" (50 µm)	All	±0.001" (25 µm)
2.0 mm	±0.002" (50 µm)	All	±0.001" (25 µm)
1/8"	±0.003" (75 µm)	All	±0.003" (75 µm)

## Application Note

### What Size PEEK Tubing Should I Use?

- ▶ It is usually safe to use 0.010" ID x 1/16" OD tubing throughout an analytical HPLC system. With a 0.010" ID, the pressure drop across most tubing lengths is negligible, and the ID is small enough to minimize band broadening.
- ▶ High pressure semi-prep LC systems will most likely use 1/8" OD tubing.
- ▶ Use 1.8 mm OD tubing to replace fluoropolymer tubing used in some Pharmacia®/GE Healthcare systems.
- ▶ Use our 1/32" OD tubing for the high pressure flow path of some Agilent 1100 LC systems.
- ▶ Choose 360 µm OD tubing for most capillary systems.
- ▶ PEEK tubing is available in additional sizes and in 50' and 100' lengths. Contact your local Distributor or IDEX Health & Science directly for pricing information.



**Top Seller** SEE STARRED PRODUCTS

Part No.	ID	Color	Max. Pressure	Price
<b>PEEK TUBING, 1/16" OD X 5'</b>				
1559	0.001" (25 µm) ID	Natural	10,000 psi (690 bar)	\$ 29.52
★ 1560	0.0025" (65 µm) ID	Natural	7,000 psi (483 bar)	22.72
★ 1561	0.004" (0.10 mm) ID	Black	7,000 psi (483 bar)	22.72
★ 1535	0.005" (0.125 mm) ID	Red	7,000 psi (483 bar)	22.72
1562	0.006" (0.15 mm) ID	Purple	7,000 psi (483 bar)	22.72
★ 1536	0.007" (0.175 mm) ID	Yellow	7,000 psi (483 bar)	15.91
★ 1531	0.010" (0.25 mm) ID	Natural	7,000 psi (483 bar)	15.91
★ 1531B	0.010" (0.25 mm) ID	Blue	7,000 psi (483 bar)	15.91
1565	0.015" (0.40 mm) ID	Gray	7,000 psi (483 bar)	15.91
★ 1532	0.020" (0.50 mm) ID	Orange	7,000 psi (483 bar)	15.91
★ 1533	0.030" (0.75 mm) ID	Green	7,000 psi (483 bar)	15.91
★ 1538	0.040" (1.00 mm) ID	Natural	5,000 psi (345 bar)	15.91
1537	0.055" (1.40 mm) ID	Natural	500 psi (34 bar)	22.72
<b>PEEK TUBING, 1/8" OD X 5'</b>				
★ 1534	0.062" (1.55 mm) ID	Natural	4,000 psi (276 bar)	\$ 32.95
1544	0.080" (2.00 mm) ID	Natural	3,000 psi (207 bar)	32.95
<b>PEEK TUBING, 1.8 MM OD X 5'</b>				
1539	0.055" (1.40 mm) ID	Natural	500 psi (34 bar)	\$ 27.27
<b>PEEK TUBING, 2.0 MM OD X 5'</b>				
1590	0.042" (1.05 mm) ID	Natural	5,000 psi (345 bar)	\$ 27.27

## Capillary PEEK™ Tubing

- ▶ 360 µm, 510 µm or 1/32" outside diameter available
- ▶ IDs as small as 25 µm (0.001")

Capillary PEEK tubing offers all the benefits of larger sized PEEK tubing, while serving as an excellent alternative to more traditional fused silica and stainless steel capillary tubing (see Application Note below). The capillary tubing can be coupled to many of the products in the Connectors chapter (starting on page 34) and to some of the valves in the Valves chapter (starting on page 125).

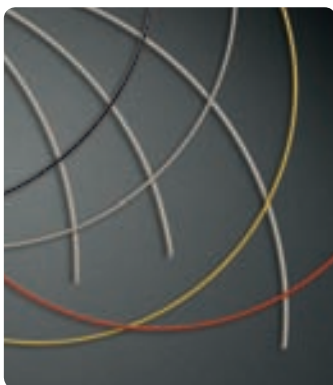

## Fused Silica Tubing

- ▶ Five inner diameters with most common capillary outside diameter, 360 µm
- ▶ Convenient 2 m lengths

As a service to our customers, we offer cut fused silica tubing in convenient 2 m lengths. These products are manufactured from synthetic fused silica with a polyimide coating.



## Specifications

### Capillary PEEK Tubing Specifications

Tubing OD	Tubing ID	OD/ID Tolerances
360 µm	All	±0.0005" (12.5 µm)
510 µm	All	±0.001" (25 µm)
1/32"	All	±0.0005" (12.5 µm)

### Fused Silica Tubing Specifications

Tubing OD	Tubing ID	OD Tolerance	ID Tolerance
360 µm	20 µm (0.0008")	±0.0004" (10 µm)	±0.00008" (2 µm)
360 µm	50 µm (0.002") and 75 µm (0.003")	±0.0004" (10 µm)	±0.00012" (3 µm)
360 µm	0.100 mm (0.004") and 0.150 mm (0.006")	±0.0004" (10 µm)	±0.00016" (4 µm)

## Application Note

- ▶ An independent study conducted by a major pharmaceutical company indicated LC-MS chromatographic performance could be improved in some cases by switching the post-column transfer line from fused silica to PEEK polymer tubing. The switch dramatically reduced peak tailing and eliminated the degradation of peak symmetry as injection volume was reduced. For more information, please contact us or order the "Improved LC-MS Results Study" from the "Request Literature" section of our website at [www.idex-hs.com](http://www.idex-hs.com).
- ▶ To straighten PEEK polymer tubing, first choose a piece of stainless steel tubing with an inner diameter slightly larger than the OD of your tubing and with an appropriate length for the PEEK tubing you wish to straighten. For instance, for 1/16" OD PEEK tubing with a length of 10", choose our U-825 tubing (stainless steel, 1/8" OD x 0.08" ID x 25 cm long, page 69). Slip your PEEK tubing into the stainless steel tubing. Place this "sleeved" tubing into an oven and bake at 425 °F (218 °C) for 30 minutes or 350 °F (177 °C) for 60 minutes. Allow the sleeved tubing to return to room temperature naturally (i.e., do not quench it with water). Once cooled, remove the PEEK tubing from the stainless steel sleeve and inspect it for straightness. If needed, repeat the process until the desired straightness is achieved.

## Note

Because the thru-hole of our 25 µm ID PEEK tubing is very small, it is possible for some fittings to cause the ID to become occluded. Please use caution, especially with wrench-tightened fittings. For more information, please contact IDEX Health & Science or your local distributor directly.



**Top Seller** SEE STARRED PRODUCTS

Part No.	ID	Color	Max. Pressure	Qty.	Price
<b>CAPILLARY PEEK TUBING, 360 µm OD</b>					
1574	25 µm (0.001") ID x 5'	Natural	5,000 psi (345 bar)	ea.	\$ 27.27
1574-12x	25 µm (0.001") ID x 12"	Natural	5,000 psi (345 bar)	10-pk	54.55
1570	50 µm (0.002") ID x 5'	Natural	2,000 psi (138 bar)	ea.	27.27
1570-12x	50 µm (0.002") ID x 12"	Natural	2,000 psi (138 bar)	10-pk	54.55
1573	75 µm (0.003") ID x 5'	Black	2,000 psi (138 bar)	ea.	27.27
1573-12x	75 µm (0.003") ID x 12"	Black	2,000 psi (138 bar)	10-pk	54.55
1571	0.100 mm (0.004") ID x 5'	Red	2,000 psi (138 bar)	ea.	27.27
1571-12x	0.100 mm (0.004") ID x 12"	Red	2,000 psi (138 bar)	10-pk	54.55
1572	0.150 mm (0.006") ID x 5'	Yellow	2,000 psi (138 bar)	ea.	27.27
1572-12x	0.150 mm (0.006") ID x 12"	Yellow	2,000 psi (138 bar)	10-pk	54.55
<b>CAPILLARY PEEK TUBING, 510 µm (0.020") OD</b>					
1543	65 µm (0.0025") ID x 5'	Natural	2,000 psi (138 bar)	ea.	\$ 27.27
★ 1541	0.125 mm (0.005") ID x 5'	Natural	2,000 psi (138 bar)	ea.	27.27
1542	0.255 mm (0.010") ID x 5'	Natural	2,000 psi (138 bar)	ea.	27.27
<b>CAPILLARY PEEK TUBING, 1/32" OD</b>					
1567	25 µm (0.001") ID x 5'	Natural	5,000 psi (345 bar)	ea.	\$ 27.27
1567-12x	25 µm (0.001") ID x 12"	Natural	5,000 psi (345 bar)	10-pk	54.55
1579	65 µm (0.0025") ID x 5'	Natural	5,000 psi (345 bar)	ea.	27.27
1579-12x	65 µm (0.0025") ID x 12"	Natural	5,000 psi (345 bar)	10-pk	54.55
1578	90 µm (0.0035") ID x 5'	Black	5,000 psi (345 bar)	ea.	27.27
1578-12x	90 µm (0.0035") ID x 12"	Black	5,000 psi (345 bar)	10-pk	54.55
1576	0.125 mm (0.005") ID x 5'	Red	5,000 psi (345 bar)	ea.	27.27
1576-12x	0.125 mm (0.005") ID x 12"	Red	5,000 psi (345 bar)	10-pk	54.55
1577	0.175 mm (0.007") ID x 5'	Yellow	5,000 psi (345 bar)	ea.	27.27
1577-12x	0.175 mm (0.007") ID x 12"	Yellow	5,000 psi (345 bar)	10-pk	54.55
1575	0.20 mm (0.008") ID x 5'	Natural	5,000 psi (345 bar)	ea.	27.27
1575-12x	0.20 mm (0.008") ID x 12"	Natural	5,000 psi (345 bar)	10-pk	54.55
1580	0.23 mm (0.009") ID x 5'	Gray	5,000 psi (345 bar)	ea.	27.27
1580-12x	0.23 mm (0.009") ID x 12"	Gray	5,000 psi (345 bar)	10-pk	54.55
1581	0.25 mm (0.010") ID x 5'	Blue	5,000 psi (345 bar)	ea.	27.27
1581-12x	0.25 mm (0.010") ID x 12"	Blue	5,000 psi (345 bar)	10-pk	54.55
1568	0.40 mm (0.015") ID x 5'	Natural	5,000 psi (345 bar)	ea.	27.27
1568-12x	0.40 mm (0.015") ID x 12"	Natural	5,000 psi (345 bar)	10-pk	54.55
★ 1569	0.50 mm (0.020") ID x 5'	Orange	3,000 psi (207 bar)	ea.	27.27
1569-12x	0.50 mm (0.020") ID x 12"	Orange	3,000 psi (207 bar)	10-pk	54.55
787-KIT	1/32" OD x 12" Kit			Kit	463.43
Kit contains (1) 10-pack of each 1/32" OD x 12" size listed above.					
<b>FUSED SILICA TUBING, 360 µm OD</b>					
★ FS-120	20 µm (0.0008") ID x 2 m (6.4')	Natural	10,000 psi (690 bar)	ea.	\$ 45.44
★ FS-150	50 µm (0.002") ID x 2 m (6.4')	Natural	10,000 psi (690 bar)	ea.	45.44
FS-175	75 µm (0.003") ID x 2 m (6.4')	Natural	10,000 psi (690 bar)	ea.	45.44
FS-110	0.10 mm (0.004") ID x 2 m (6.4')	Natural	10,000 psi (690 bar)	ea.	45.44
FS-115	0.15 mm (0.006") ID x 2 m (6.4')	Natural	10,000 psi (690 bar)	ea.	45.44

## PEEKsil™ Tubing

- ▶ PEEK™ covered fused silica
- ▶ 360 µm, 1/32" or 1/16" outside diameter with wide variety of inside diameters
- ▶ Precut to a wide variety of lengths

PEEKsil's sheathing is mechanically strong and has ideal characteristics for sealing with metal or polymer fittings. The fused silica core provides a consistent and rigid fluid pathway with very tight tolerances and industry-accepted chemical properties. Together, this makes PEEKsil tubing ideal for many applications. In fact, PEEKsil can be used as a direct replacement for conventional stainless steel or PEEK tubing in many analytical systems.

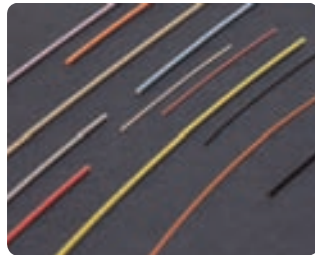

Like traditional fused silica tubing, PEEKsil has excellent chemical compatibility and extremely low adsorption characteristics, especially when compared with stainless steel.

*Please Note: Do not cut this tubing. It should be used at its precut lengths because of permanent damage caused by conventional cutters.*

### PEEKsil Tubing

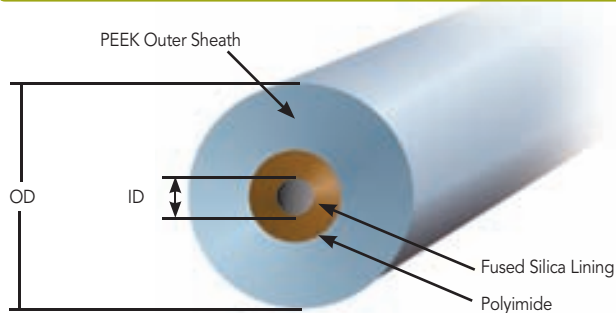

### Specifications

Tubing OD	OD Tolerance	Tubing ID	ID Tolerance
360 µm	±0.0004" (10 µm)	25 µm	±0.00004" (1 µm)
1/32"	±0.0008" (20 µm)	50 - 100 µm	±0.00012" (3 µm)
1/16"	±0.0012" (30 µm)	0.15 - 0.30 mm	±0.0002" (5 µm)



**Top Seller** SEE STARRED PRODUCTS

Part No.	ID	Length	Color	Max. Pressure*	Qty.	Price
<b>PEEKsil TUBING, 360 µm OD</b>						
360255	25 µm (0.001")	5 cm (2")	Orange	10,000 psi (690 bar)	2-pk	\$ 22.95
3602510	25 µm (0.001")	10 cm (4")	Orange	10,000 psi (690 bar)	2-pk	52.50
3602515	25 µm (0.001")	15 cm (6")	Orange	10,000 psi (690 bar)	2-pk	61.08
3602525	25 µm (0.001")	25 cm (10")	Orange	10,000 psi (690 bar)	2-pk	76.44
3602550	25 µm (0.001")	50 cm (1.6')	Orange	10,000 psi (690 bar)	2-pk	141.74
360505	50 µm (0.002")	5 cm (2")	Natural	10,000 psi (690 bar)	2-pk	37.07
3605010	50 µm (0.002")	10 cm (4")	Natural	10,000 psi (690 bar)	2-pk	50.45
3605015	50 µm (0.002")	15 cm (6")	Natural	10,000 psi (690 bar)	2-pk	59.04
3605025	50 µm (0.002")	25 cm (10")	Natural	10,000 psi (690 bar)	2-pk	92.21
3605050	50 µm (0.002")	50 cm (1.6')	Natural	10,000 psi (690 bar)	2-pk	186.58

Part No.	ID	Length	Color	Max. Pressure*	Qty.	Price
<b>PEEKsil TUBING, 1/32" OD</b>						
3255	25 µm (0.001")	5 cm (2")	Orange	10,000 psi (690 bar)	2-pk	\$ 19.52
★ 32510	25 µm (0.001")	10 cm (4")	Orange	10,000 psi (690 bar)	2-pk	21.24
32515	25 µm (0.001")	15 cm (6")	Orange	10,000 psi (690 bar)	2-pk	26.25
32520	25 µm (0.001")	20 cm (8")	Orange	10,000 psi (690 bar)	2-pk	34.70
32550	25 µm (0.001")	50 cm (1.6')	Orange	10,000 psi (690 bar)	2-pk	54.88
3505	50 µm (0.002")	5 cm (2")	Natural	10,000 psi (690 bar)	2-pk	19.52
35010	50 µm (0.002")	10 cm (4")	Natural	10,000 psi (690 bar)	2-pk	21.24
35015	50 µm (0.002")	15 cm (6")	Natural	10,000 psi (690 bar)	2-pk	26.25
35020	50 µm (0.002")	20 cm (8")	Natural	10,000 psi (690 bar)	2-pk	34.70
★ 35050	50 µm (0.002")	50 cm (1.6')	Natural	10,000 psi (690 bar)	2-pk	54.88
3755	75 µm (0.003")	5 cm (2")	Black	10,000 psi (690 bar)	2-pk	19.52
37510	75 µm (0.003")	10 cm (4")	Black	10,000 psi (690 bar)	2-pk	21.24
37515	75 µm (0.003")	15 cm (6")	Black	10,000 psi (690 bar)	2-pk	26.25
37520	75 µm (0.003")	20 cm (8")	Black	10,000 psi (690 bar)	2-pk	34.70
37550	75 µm (0.003")	50 cm (1.6')	Black	10,000 psi (690 bar)	2-pk	54.88
31005	0.10 mm (0.004")	5 cm (2")	Red	10,000 psi (690 bar)	2-pk	19.52
310010	0.10 mm (0.004")	10 cm (4")	Red	10,000 psi (690 bar)	2-pk	21.24
310015	0.10 mm (0.004")	15 cm (6")	Red	10,000 psi (690 bar)	2-pk	26.25
310020	0.10 mm (0.004")	20 cm (8")	Red	10,000 psi (690 bar)	2-pk	34.70
310050	0.10 mm (0.004")	50 cm (1.6')	Red	10,000 psi (690 bar)	2-pk	54.88
31505	0.15 mm (0.006")	5 cm (2")	Purple	10,000 psi (690 bar)	2-pk	19.52
315010	0.15 mm (0.006")	10 cm (4")	Purple	10,000 psi (690 bar)	2-pk	21.24
315015	0.15 mm (0.006")	15 cm (6")	Purple	10,000 psi (690 bar)	2-pk	26.25
315020	0.15 mm (0.006")	20 cm (8")	Purple	10,000 psi (690 bar)	2-pk	34.70
★ 315050	0.15 mm (0.006")	50 cm (1.6')	Purple	10,000 psi (690 bar)	2-pk	54.88
<b>PEEKsil TUBING, 1/16" OD</b>						
6255	25 µm (0.001")	5 cm (2")	Orange	10,000 psi (690 bar)	5-pk	\$ 44.72
62510	25 µm (0.001")	10 cm (4")	Orange	10,000 psi (690 bar)	5-pk	54.88
62515	25 µm (0.001")	15 cm (6")	Orange	10,000 psi (690 bar)	5-pk	65.10
62520	25 µm (0.001")	20 cm (8")	Orange	10,000 psi (690 bar)	5-pk	77.03
62550	25 µm (0.001")	50 cm (1.6')	Orange	10,000 psi (690 bar)	2-pk	54.88
6505	50 µm (0.002")	5 cm (2")	Natural	10,000 psi (690 bar)	5-pk	44.72
65010	50 µm (0.002")	10 cm (4")	Natural	10,000 psi (690 bar)	5-pk	54.88
65015	50 µm (0.002")	15 cm (6")	Natural	10,000 psi (690 bar)	5-pk	65.10
★ 65020	50 µm (0.002")	20 cm (8")	Natural	10,000 psi (690 bar)	5-pk	77.03
65050	50 µm (0.002")	50 cm (1.6')	Natural	10,000 psi (690 bar)	2-pk	54.88
6755	75 µm (0.003")	5 cm (2")	Black	10,000 psi (690 bar)	5-pk	44.72
67510	75 µm (0.003")	10 cm (4")	Black	10,000 psi (690 bar)	5-pk	54.88
67515	75 µm (0.003")	15 cm (6")	Black	10,000 psi (690 bar)	5-pk	65.10
67520	75 µm (0.003")	20 cm (8")	Black	10,000 psi (690 bar)	5-pk	77.03
67550	75 µm (0.003")	50 cm (1.6')	Black	10,000 psi (690 bar)	2-pk	54.88
61005	0.10 mm (0.004")	5 cm (2")	Red	10,000 psi (690 bar)	5-pk	44.72
610010	0.10 mm (0.004")	10 cm (4")	Red	10,000 psi (690 bar)	5-pk	54.88
610015	0.10 mm (0.004")	15 cm (6")	Red	10,000 psi (690 bar)	5-pk	65.10
610020	0.10 mm (0.004")	20 cm (8")	Red	10,000 psi (690 bar)	5-pk	77.03
610050	0.10 mm (0.004")	50 cm (1.6')	Red	10,000 psi (690 bar)	2-pk	54.88
61505	0.15 mm (0.006")	5 cm (2")	Purple	10,000 psi (690 bar)	5-pk	44.72
615010	0.15 mm (0.006")	10 cm (4")	Purple	10,000 psi (690 bar)	5-pk	54.88
615015	0.15 mm (0.006")	15 cm (6")	Purple	10,000 psi (690 bar)	5-pk	65.10
615020	0.15 mm (0.006")	20 cm (8")	Purple	10,000 psi (690 bar)	5-pk	77.03
615050	0.15 mm (0.006")	50 cm (1.6')	Purple	10,000 psi (690 bar)	2-pk	54.88
61755	0.175 mm (0.007")	5 cm (2")	Yellow	10,000 psi (690 bar)	5-pk	44.72
617510	0.175 mm (0.007")	10 cm (4")	Yellow	10,000 psi (690 bar)	5-pk	54.88
617515	0.175 mm (0.007")	15 cm (6")	Yellow	10,000 psi (690 bar)	5-pk	65.10
617520	0.175 mm (0.007")	20 cm (8")	Yellow	10,000 psi (690 bar)	5-pk	77.03
617550	0.175 mm (0.007")	50 cm (1.6')	Yellow	10,000 psi (690 bar)	2-pk	54.88
62005	0.20 mm (0.008")	5 cm (2")	Blue	10,000 psi (690 bar)	5-pk	44.72
620010	0.20 mm (0.008")	10 cm (4")	Blue	10,000 psi (690 bar)	5-pk	54.88
620015	0.20 mm (0.008")	15 cm (6")	Blue	10,000 psi (690 bar)	5-pk	65.10
620020	0.20 mm (0.008")	20 cm (8")	Blue	10,000 psi (690 bar)	5-pk	77.03
620050	0.20 mm (0.008")	50 cm (1.6')	Blue	10,000 psi (690 bar)	2-pk	54.88
63005	0.30 mm (0.012")	5 cm (2")	Gray	10,000 psi (690 bar)	5-pk	44.72
630010	0.30 mm (0.012")	10 cm (4")	Gray	10,000 psi (690 bar)	5-pk	54.88
630015	0.30 mm (0.012")	15 cm (6")	Gray	10,000 psi (690 bar)	5-pk	65.10
630020	0.30 mm (0.012")	20 cm (8")	Gray	10,000 psi (690 bar)	5-pk	77.03
630050	0.30 mm (0.012")	50 cm (1.6')	Gray	10,000 psi (690 bar)	2-pk	54.88

\* Pressure rating determined by SGE International Pty, Ltd, the manufacturer of this tubing.

## Spiral-Link™ Tubing

- ▶ Preformed PEEK™ tubing into a convenient spiral for a sample loop or to facilitate tubing movement
- ▶ Many volumes available

The coils of our 1/16" OD Spiral-Link tubing expand and contract, allowing you to more easily move your system components or even make equipment repairs whenever needed, without the hassle of breaking connections.



Upchurch Scientific® Spiral-Link tubing is made of PEEK polymer, a biocompatible, chemically inert material. Spiral-Links come in six different lengths. Our proprietary extrusion process ensures color permanence.

Each Spiral-Link ships with two F-287 SealTight™ Fittings.

### Note

In addition to 0.010" ID shown in the price block below, Spiral-Link tubing is also available with the following IDs: 0.005" (125 µm), 0.020" (0.50 mm) and 0.030" (0.75 mm), all with 1/16" OD. Please contact us or an IDEX Health & Science Distributor for more information, or find these products at [www.idex-hs.com](http://www.idex-hs.com).

### Related Products

Some customers report using longer lengths of polymer tubing to add a little back pressure to their system. A more precise way to achieve this objective is to use one of our Back Pressure Regulators, found on page 152.



## Radel® Tubing

- ▶ Withstands up to 12,500 psi (862 bar)
- ▶ Transparent and autoclavable
- ▶ 1/16" or 1/8" outside diameter available
- ▶ Maximum continuous use temperature: 100 °C

Radel (polyphenylsulfone) is a mechanically strong and chemically resistant material, much like PEEK. Radel is frequently used in medical applications where repeated autoclave sterilization is performed (tests show product stability even after 1,000 cycles). Radel tubing is also transparent, allowing technicians to visually monitor flow through their instrument. Readily wetted surfaces help keep air bubbles from accumulating on inner surfaces.

Please visit our website, [www.idex-hs.com](http://www.idex-hs.com), for more information regarding chemical compatibility of Radel.

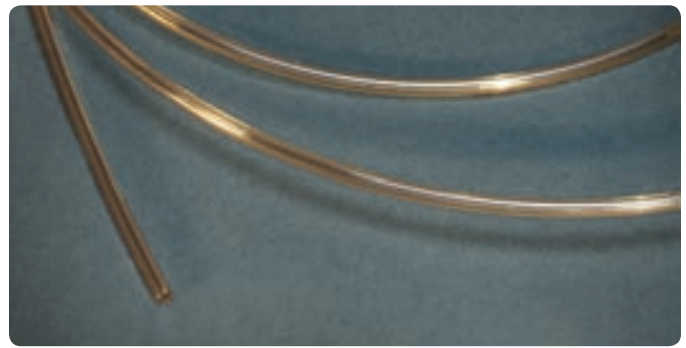

### Radel Tubing Specifications

Tubing OD	OD Tolerance	Tubing ID	ID Tolerance
1/16"	±0.001" (25 µm)	All	±0.001" (25 µm)
1/8"	±0.003" (75 µm)	All	±0.003" (75 µm)



**Top Seller** SEE STARRED PRODUCTS

Part No.	ID	Length (Prior to Coiling)	Max coil span	Volume	Price	
<b>SPIRAL LINK TUBING, 1/16" OD</b>						
17202	0.25 mm (0.010")	20 cm (8")	1.3 cm (0.5")	10 µL	\$ 20.40	
17204	0.25 mm (0.010")	40 cm (15.75")	6.1 cm (2.4")	20 µL	24.50	
17205	0.25 mm (0.010")	50 cm (19.69")	7.6 cm (3.0")	25 µL	24.50	
17210	0.25 mm (0.010")	100 cm (39.37")	17.8 cm (7.0")	51 µL	31.76	
17220	0.25 mm (0.010")	200 cm (78.74")	33 cm (13.0")	101 µL	31.76	
<b>RADEL TUBING, 1/16" OD</b>						
Part No.	ID	Length	Color	Max Pressure	Volume	Price
1210	0.25 mm (0.010")	1.5 m (5')	Natural	12,500 psi (862 bar)	N/A	\$ 27.27
1210L	0.25 mm (0.010")	15 m (50')	Natural	12,500 psi (862 bar)	N/A	272.62
1210XL	0.25 mm (0.010")	30 m (100')	Natural	12,500 psi (862 bar)	N/A	463.47
1220	0.50 mm (0.020")	1.5 m (5')	Natural	7,500 psi (518 bar)	N/A	27.27
1220L	0.50 mm (0.020")	15 m (50')	Natural	7,500 psi (518 bar)	N/A	272.62
1220XL	0.50 mm (0.020")	30 m (100')	Natural	7,500 psi (518 bar)	N/A	463.47
1230	0.75 mm (0.030")	1.5 m (5')	Natural	5,500 psi (379 bar)	N/A	27.27
1230L	0.75 mm (0.030")	15 m (50')	Natural	5,500 psi (379 bar)	N/A	272.62
1230XL	0.75 mm (0.030")	30 m (100')	Natural	5,500 psi (379 bar)	N/A	463.47
<b>RADEL TUBING, 1/8" OD</b>						
1235	1.55 mm (0.062")	1.5 m (5')	Natural	4,500 psi (310 bar)	N/A	\$ 39.55
1235L	1.55 mm (0.062")	15 m (50')	Natural	4,500 psi (310 bar)	N/A	395.32
★ 1235XL	1.55 mm (0.062")	30 m (100')	Natural	4,500 psi (310 bar)	N/A	672.01

## Stainless Steel Tubing

- ▶ Precut 316 stainless steel\*
- ▶ Color-coded banding for easy identification

IDEX Health & Science seamless, precut stainless steel tubing is designed to meet the exacting requirements of today's analyses. We machine cut and polish each end, deburr the inside and outside edges and passivate the tubing (please see the passivation information box on this page). Finally, we flush reagent-grade isopropanol through each piece.

Our thorough preparation and cleaning procedure guarantees tubing that is truly ready-to-use, with flat, burr-free ends and a clean finish. This care is important in achieving zero-dead-volume connections and good chromatographic results.

We offer a variety of precut lengths as well as longer lengths (5' and 25') of some sizes. Cutting the tubing disturbs and roughens the tubing's end surface, so we recommend using our precut tubing whenever possible. If you need to cut tubing to custom lengths, we suggest you then passivate the tubing. For a description of a cold passivation process, please contact IDEX Health & Science or visit our website at [www.idex-hs.com](http://www.idex-hs.com) and search for "stainless steel tubing."

*\* Except our 0.020" OD Stainless Steel Tubing, which is manufactured from 304 series stainless steel*



## Specifications

- ▶ Maximum Recommended Operating Temperature: 750 °F (399 °C)
- ▶ Rockwell Hardness (B): Maximum of 95
- ▶ Meets ASTM A269 and A213

Tubing OD	OD Tolerance	Tubing ID	ID Tolerance
0.020"	±0.0005" (12.5 µm)	All	±0.0005" (12.5 µm)
1/32"	+0.002"/-0.000" (+50 µm/-0 µm)	All, except 0.004" (0.10 mm)	+0.000"/-0.002" (+0 µm/-50 µm)
1/32"	+0.002"/-0.000" (+50 µm/-0 µm)	0.004" (0.10 mm)	+0.002"/-0.000" (+50 µm/-0 µm)
1/16"	+0.002"/-0.000" (+50 µm/-0 µm)	All	±0.001" (25 µm)
1/8"	±0.003" (75 µm)	All	±0.003" (75 µm)

## Note

PEEK™ polymer tubing can be used to replace stainless steel tubing in most liquid analytical systems. Unlike stainless steel tubing, PEEK tubing is biocompatible, flexible and can easily be cut to desired lengths. See page 64.

## Related Products

- ▶ Our 0.020" OD tubing is the size of choice for the Rheodyne® Model 8125 Micro-Scale Injector Valve (page 131).
- ▶ PEEK polymer tubing is available in all of these sizes, listed on page 64.

## Stainless Steel Tubing Passivation

Stainless steel is naturally self-passivating, forming an oxidized layer on newly created surfaces. IDEX Health & Science takes extra steps to ensure the chemical resistance of our stainless steel tubing by manually passivating before and after the tubing is cut into specified lengths (except in a few cases where size is prohibitive). In the precut stage, the internal wall is acid passivated and flushed. After the tubing is cut, deburred and polished, it is completely submerged in an acid passivation bath and again flushed clean. The table below summarizes the manual passivation steps performed for each size of our stainless steel tubing:

Tubing OD	Precut Passivation	Postcut Passivation
0.020"	All	All
1/32"	All	All
1/16"	All	All, ex. 25' lengths
1/8"	None	All, ex. 3 & 5 m lengths

## Application Note

- ▶ Our 1/32" OD tubing is designed for plumbing the Agilent 1100 Capillary LC system.
- ▶ Standard 1/16" and 1/8" OD stainless steel tubing is suited for most analytical applications.

## High Pressure Tubing

### Stainless Steel Tubing (continued)

#### The Beauty of Precut Tubing

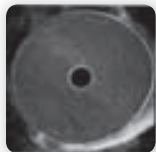

Precut tubing

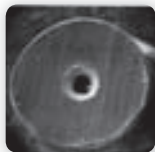

Tubing cut by a commercially available tubing cutter

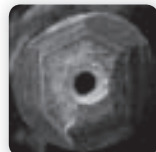

File cut tubing

#### Note



All Stainless Steel tubing longer than 1 m is coiled.



**Top Seller** SEE STARRED PRODUCTS

Part No.	ID	Length	Color	Price
<b>STAINLESS STEEL, 0.020" OD</b>				
U-119	0.005" (0.125 mm)	5 cm (2")	N/A	\$ 4.77
U-120	0.005" (0.125 mm)	10 cm (4")	N/A	5.25
U-121	0.005" (0.125 mm)	20 cm (8")	N/A	7.17
U-122	0.005" (0.125 mm)	30 cm (12")	N/A	10.03
U-123	0.005" (0.125 mm)	50 cm (1.6')	N/A	17.47
U-124	0.005" (0.125 mm)	1 m (3.2')	N/A	32.48
U-125	0.005" (0.125 mm)	1.5 m (5')	N/A	43.24
<b>STAINLESS STEEL, 1/32" OD</b>				
U-1114	0.004" (0.10 mm)	5 cm (2")	Red	\$ 3.86
U-1115	0.004" (0.10 mm)	10 cm (4")	Red	5.15
U-1116	0.004" (0.10 mm)	20 cm (8")	Red	7.87
U-1117	0.004" (0.10 mm)	30 cm (12")	Red	10.66
U-1120	0.006" (0.15 mm)	5 cm (2")	Yellow	3.86
U-1121	0.006" (0.15 mm)	10 cm (4")	Yellow	5.15
U-1122	0.006" (0.15 mm)	20 cm (8")	Yellow	7.87
U-1123	0.006" (0.15 mm)	30 cm (12")	Yellow	10.66
U-1125	0.008" (0.20 mm)	5 cm (2")	Clear	3.75
U-1126	0.008" (0.20 mm)	10 cm (4")	Clear	5.15
U-1127	0.008" (0.20 mm)	20 cm (8")	Clear	7.87
★ U-1128	0.008" (0.20 mm)	30 cm (12")	Clear	10.66
U-1130	0.010" (0.25 mm)	5 cm (2")	Blue	3.86
U-1131	0.010" (0.25 mm)	10 cm (4")	Blue	5.15
U-1132	0.010" (0.25 mm)	20 cm (8")	Blue	7.87
U-1133	0.010" (0.25 mm)	30 cm (12")	Blue	10.66
U-1140	0.015" (0.40 mm)	5 cm (2")	Green	3.86
U-1141	0.015" (0.40 mm)	10 cm (4")	Green	5.15
U-1142	0.015" (0.40 mm)	20 cm (8")	Green	7.87
U-1143	0.015" (0.40 mm)	30 cm (12")	Green	10.66
U-1145	0.018" (0.45 mm)	5 cm (2")	Black	3.86
U-1146	0.018" (0.45 mm)	10 cm (4")	Black	5.15
U-1147	0.018" (0.45 mm)	20 cm (8")	Black	7.87
U-1148	0.018" (0.45 mm)	30 cm (12")	Black	10.66

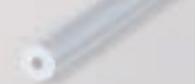
Part No.	ID	Length	Color	Price
<b>STAINLESS STEEL, 1/16" OD</b>				
U-152	0.005" (0.125 mm)	5 cm (2")	Red	\$ 3.54
U-153	0.005" (0.125 mm)	10 cm (4")	Red	4.66
U-154	0.005" (0.125 mm)	20 cm (8")	Red	6.80
U-155	0.005" (0.125 mm)	30 cm (12")	Red	8.96
U-156	0.005" (0.125 mm)	0.5 m (1.6')	Red	13.39
U-157	0.005" (0.125 mm)	1 m (3.2')	Red	24.38
U-158	0.005" (0.125 mm)	1.5 m (5')	Red	35.84
U-160	0.005" (0.125 mm)	7.6 m (25')	Red	169.26
U-126	0.007" (0.175 mm)	5 cm (2")	Black	3.43
U-127	0.007" (0.175 mm)	10 cm (4")	Black	4.40
U-128	0.007" (0.175 mm)	20 cm (8")	Black	6.27
U-129	0.007" (0.175 mm)	30 cm (12")	Black	8.19
U-130	0.007" (0.175 mm)	0.5 m (1.6')	Black	12.00
U-131	0.007" (0.175 mm)	1 m (3.2')	Black	21.59
U-108	0.007" (0.175 mm)	5 m (16')	Black	31.61
U-161	0.007" (0.175 mm)	7.6 m (25')	Black	148.47
★ U-111	0.010" (0.25 mm)	5 cm (2")	Blue	3.43
★ U-112	0.010" (0.25 mm)	10 cm (4")	Blue	4.40
U-113	0.010" (0.25 mm)	20 cm (8")	Blue	6.27
★ U-114	0.010" (0.25 mm)	30 cm (12")	Blue	8.19
U-132	0.010" (0.25 mm)	0.5 m (1.6')	Blue	12.00
U-133	0.010" (0.25 mm)	1 m (3.2')	Blue	21.59
U-106	0.010" (0.25 mm)	5 m (16')	Blue	31.61
U-162	0.010" (0.25 mm)	7.6 m (25')	Blue	148.47
U-101	0.020" (0.5 mm)	5 cm (2")	Yellow	3.26
U-102	0.020" (0.5 mm)	10 cm (4")	Yellow	4.08
U-103	0.020" (0.5 mm)	20 cm (8")	Yellow	5.73
U-104	0.020" (0.5 mm)	30 cm (12")	Yellow	7.40
U-134	0.020" (0.5 mm)	0.5 m (1.6')	Yellow	10.66
U-135	0.020" (0.5 mm)	1 m (3.2')	Yellow	18.86
★ U-105	0.020" (0.5 mm)	5 m (16')	Yellow	27.48
U-163	0.020" (0.5 mm)	7.6 m (25')	Yellow	127.57
U-115	0.030" (0.75 mm)	5 cm (2")	White	3.43
U-116	0.030" (0.75 mm)	10 cm (4")	White	4.40
U-117	0.030" (0.75 mm)	20 cm (8")	White	6.27
U-118	0.030" (0.75 mm)	30 cm (12")	White	8.19
U-136	0.030" (0.75 mm)	0.5 m (1.6')	White	12.00
U-137	0.030" (0.75 mm)	1 m (3.2')	White	21.59
★ U-107	0.030" (0.75 mm)	5 m (16')	White	31.61
★ U-164	0.030" (0.75 mm)	7.6 m (25')	White	148.47
U-138	0.040" (1.0 mm)	5 cm (2")	N/A	4.93
U-139	0.040" (1.0 mm)	10 cm (4")	N/A	7.40
U-140	0.040" (1.0 mm)	20 cm (8")	N/A	12.27
U-141	0.040" (1.0 mm)	30 cm (12")	N/A	17.20
U-142	0.040" (1.0 mm)	0.5 m (1.6')	N/A	27.11
U-143	0.040" (1.0 mm)	1 m (3.2')	N/A	51.71
U-144	0.040" (1.0 mm)	5 m (16')	N/A	77.53
★ U-165	0.040" (1.0 mm)	7.6 m (25')	N/A	265.22
U-145	0.046" (1.15 mm)	5 cm (2")	N/A	5.15
U-146	0.046" (1.15 mm)	10 cm (4")	N/A	7.87
U-147	0.046" (1.15 mm)	20 cm (8")	N/A	13.39
U-148	0.046" (1.15 mm)	30 cm (12")	N/A	18.86
U-149	0.046" (1.15 mm)	0.5 m (1.6')	N/A	29.73
U-150	0.046" (1.15 mm)	1 m (3.2')	N/A	57.17
U-151	0.046" (1.15 mm)	5 m (16')	N/A	85.88
<b>STAINLESS STEEL, 1/8" OD</b>				
U-815	0.080" (2.0 mm)	15 cm (6")	N/A	\$ 8.19
U-825	0.080" (2.0 mm)	25 cm (10")	N/A	12.00
U-800	0.080" (2.0 mm)	1 m (3.2')	N/A	40.72
U-803	0.080" (2.0 mm)	3 m (9.8')	N/A	117.39
U-805	0.080" (2.0 mm)	5 m (16')	N/A	194.01

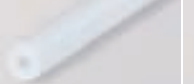
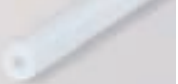
						
TUBING	DuPONT® FEP	DuPONT PFA	DuPONT HIGH PURITY PFA	360 µm DuPONT HIGH PURITY PFA	DuPONT ETFE	HALAR® (ECTFE)
Page	71	72	72	72	73	73
Description	<p>FEP tubing is a great alternative to traditional PTFE tubing, desirable for use because it is chemically inert to most solvents, easy to cut, and translucent for easy monitoring of solutions passing through.</p> <ul style="list-style-type: none"> <li>Great for general, low pressure applications</li> <li>Many sizes available in multiple colors for easy identification</li> <li>Tight manufacturing tolerances to ensure product consistency</li> </ul>	<p>Offers excellent chemical compatibility, plus due to its inner surface smoothness, PFA tubing tends to be more translucent than PTFE tubing.</p> <ul style="list-style-type: none"> <li>Offers higher purity and enhanced translucence when compared with other fluoropolymer tubes</li> <li>Great for more critical, low pressure applications</li> </ul>	<p>This polymer tubing is manufactured from a premium grade of PFA — one of the most contaminant-free polymers on the market.</p> <ul style="list-style-type: none"> <li>Offers chemical stability, mechanical strength and purity for applications such as medical, diagnostic, pharmaceutical, biotechnology and semiconductor</li> <li>Excellent replacement for PTFE where gas permeability and surface texture are issues</li> <li>Clarity of tubing makes PFA an excellent choice for monitoring fluid movement</li> </ul>	<p>This tubing offers excellent chemical compatibility, transparency, very low contaminant levels and is available in the most commonly-used outside diameter for capillary tubing applications.</p> <ul style="list-style-type: none"> <li>Replacement for capillary tubing in low pressure applications where excellent chemical compatibility is required</li> <li>Tubing sleeves available for capillary tubing connections</li> </ul>	<p>ETFE is chemically inert and more suitable for higher pressure applications (when using aqueous mobile phases) than PTFE, FEP and PFA. Additionally, because ETFE is more rigid than PTFE, FEP and PFA, this tubing better resists inner diameter collapse.</p> <ul style="list-style-type: none"> <li>Excellent solvent resistance</li> <li>More durable and less gas permeable than PTFE, FEP and PFA</li> <li>Operating temperatures up to 80 °C</li> </ul>	<p>Chemically inert to many solvents, easy to cut, Halar is stronger than identically sized tubing manufactured from other fluoropolymers. The material offers much better radiation resistance than most other fluoropolymers as well, which is beneficial for medical applications where radiation-based sterilization must take place.</p> <ul style="list-style-type: none"> <li>Highest pressure resistance of all fluoropolymer tubing</li> <li>Tight manufacturing tolerances to ensure product consistency</li> <li>Good choice for medical applications due to radiation resistance</li> </ul>
Specifications						
OD (outside diameter)	1/32" (785 µm), 0.040" (1.0 mm), 1/16" (1.6 mm), 0.080" (2.0 mm), 0.120" (3.0 mm), 1/8" (3.2 mm), 0.160" (4.0 mm), 3/16" (4.8 mm), 1/4" (6.35 mm), 5/16" (7.94 mm)	1/16" (1.6 mm), 1/8" (3.2 mm)	1/16" (1.6 mm), 1/8" (3.2 mm), 3/16" (4.8 mm), 1/4" (6.35 mm)	0.0145" (360 µm)	1/16" (1.6 mm), 1/8" (3.2 mm), 1/4" (6.35 mm)	1/16" (1.6 mm), 1/8" (3.2 mm)
ID (inside diameter)	0.003" (0.075 mm) – 0.250" (6.35 mm)	0.020" (0.50 mm) – 0.062" (1.55 mm)	0.020" (0.50 mm) – 0.188" (4.80 mm)	0.002" (50 µm) – 0.006" (150 µm)	0.010" (0.25 mm) – 0.188" (4.80 mm)	0.010" (0.25 mm) – 0.062" (1.55mm)
Operating Temp	-51 to 50 °C	-51 to 80 °C	-51 to 80 °C	-51 to 80 °C	-51 to 80 °C	-51 to 50 °C
Pressure Rating	2,500 – 4,000 psi (172 – 276 bar)	500 – 2,000 psi (34 – 138 bar)	250 – 2,000 psi (17 – 138 bar)	1,750 – 3,500 psi (121 – 241 bar)	250 – 4,000 psi (17 – 276 bar)	2,500 – 6,000 psi (172 – 414 bar)
Typical Tolerances	±0.001" (25 µm) for 1/16" OD tubing, ±0.003" (75 µm) for 1/8" OD tubing	±0.001" (25 µm) for 1/16" OD tubing, ±0.003" (75 µm) for 1/8" OD tubing	±0.001" (25 µm) for 1/16" OD tubing	±0.0005" (12.5 µm)	±0.001" (25 µm) for 1/16" OD tubing, ±0.003" (75 µm) for 1/8" OD tubing	±0.001" (25 µm) for 1/16" OD tubing, ±0.003" (75 µm) for 1/8" OD tubing
Refractive Index (Clarity)	1.338	1.34	1.34	1.34	1.4	1.447
pH Range	0–14	0–14	0–14	0–14	0–14	1–14
Sterilization Techniques	ethylene oxide; thermal	ethylene oxide; thermal	gamma irradiation; ethylene oxide; thermal	gamma irradiation; ethylene oxide; thermal	ethylene oxide	gamma irradiation; thermal
Autoclavable?	Y	Y	Y	Y	Y	Y

## DuPont® FEP Fluoropolymer Tubing

- ▶ Great for moderate-to-low pressure applications
- ▶ 1/32", 1/16", 1/8", 3/16", 1/4" or 5/16" outside diameter available
- ▶ 1 mm, 2 mm, 3 mm or 4 mm outside diameter available
- ▶ Maximum continuous use temperature: 50 °C

With virtually identical chemical resistance to PFA at a lower price, FEP tubing is great for general, low pressure applications. Compared to PTFE, FEP (fluorinated ethylene propylene) tubing is held to tighter tolerances and has lower gas permeability (see material properties on our website: [www.idex-hs.com](http://www.idex-hs.com)).

Much of our FEP Tubing—even the color-tinted options—is translucent, making it possible to watch fluid flow. Using different colored tubing can help identify transfer lines in multisolvent systems. Color coding also allows easy identification of the tubing thru-hole size. Black FEP tubing is available for light-sensitive applications (such as enzymatic and chemiluminescent reactions) and entering/exiting flow cells.



## Specifications

Tubing Size	Tolerances	
	OD	ID
1/32" OD	±0.0005" (12.5 µm)	±0.0005" (12.5 µm)
1/16" OD	±0.001" (25 µm)	±0.001" (25 µm)
1/8" OD	±0.003" (76 µm)	±0.003" (76 µm)
3/16" OD	±0.004" (102 µm)	±0.004" (102 µm)
5/16" OD	±0.004" (102 µm)	±0.004" (102 µm)
1 mm OD	±0.001" (25 µm)	±0.001" (25 µm)
2 mm OD	±0.003" (75 µm)	±0.003" (75 µm)
3 mm OD	±0.003" (75 µm)	±0.003" (75 µm)
4 mm OD	±0.004" (0.10 mm)	±0.004" (0.10 mm)



**Top Seller** SEE STARRED PRODUCTS

Part No.	ID	Length	Color	Max. Pressure	Price
<b>FEP TUBING, 1/32" OD</b>					
1683	75 µm (0.003")	1.5 m (5')	Natural	4,000 psi (276 bar)	\$ 21.92
1684	0.10 mm (0.004")	1.5 m (5')	Black	3,000 psi (207 bar)	21.92
1685	0.125 mm (0.005")	1.5 m (5')	Red	3,000 psi (207 bar)	21.92
1686	0.15 mm (0.006")	1.5 m (5')	Violet	3,000 psi (207 bar)	21.92
1687	0.175 mm (0.007")	1.5 m (5')	Yellow	3,000 psi (207 bar)	21.92
1688	0.20 mm (0.008")	1.5 m (5')	Natural	2,500 psi (172 bar)	21.92
1689	0.23 mm (0.009")	1.5 m (5')	Blue	2,500 psi (172 bar)	21.92
1692	0.405 mm (0.016")	1.5 m (5')	Natural	1,500 psi (104 bar)	21.92

Part No.	ID	Length	Color	Max. Pressure	Price
<b>FEP TUBING, 1/16" OD</b>					
1474	0.004" (0.10 mm)	3 m (10')	Black	4,000 psi (276 bar)	\$ 43.83
1474-20	0.004" (0.10 mm)	6 m (20')	Black	4,000 psi (276 bar)	87.71
1475	0.005" (0.125 mm)	3 m (10')	Red	4,000 psi (276 bar)	43.83
1475-20	0.005" (0.125 mm)	6 m (20')	Red	4,000 psi (276 bar)	87.71
1476	0.006" (0.150 mm)	3 m (10')	Violet	4,000 psi (276 bar)	43.83
1476-20	0.006" (0.150 mm)	6 m (20')	Violet	4,000 psi (276 bar)	87.71
1477	0.007" (0.175 mm)	3 m (10')	Yellow	4,000 psi (276 bar)	43.83
1477-20	0.007" (0.175 mm)	6 m (20')	Yellow	4,000 psi (276 bar)	87.71
1478	0.008" (0.20 mm)	3 m (10')	Natural	4,000 psi (276 bar)	43.83
1478-20	0.008" (0.20 mm)	6 m (20')	Natural	4,000 psi (276 bar)	87.71
1479	0.009" (0.23 mm)	3 m (10')	Blue	4,000 psi (276 bar)	43.83
1479-20	0.009" (0.23 mm)	6 m (20')	Blue	4,000 psi (276 bar)	87.71
1526	0.010" (0.25 mm)	3 m (10')	Natural	3,000 psi (207 bar)	20.46
1526B	0.010" (0.25 mm)	3 m (10')	Blue	3,000 psi (207 bar)	20.46
1527	0.010" (0.25 mm)	6 m (20')	Natural	3,000 psi (207 bar)	40.88
1527B	0.010" (0.25 mm)	6 m (20')	Blue	3,000 psi (207 bar)	40.88
1518	0.020" (0.50 mm)	3 m (10')	Black	2,000 psi (138 bar)	17.04
1549	0.020" (0.50 mm)	3 m (10')	Natural	2,000 psi (138 bar)	17.04
1549OR	0.020" (0.50 mm)	3 m (10')	Orange	2,000 psi (138 bar)	17.04
1519	0.020" (0.50 mm)	6 m (20')	Black	2,000 psi (138 bar)	34.08
★ 1548	0.020" (0.50 mm)	6 m (20')	Natural	2,000 psi (138 bar)	34.08
1548OR	0.020" (0.50 mm)	6 m (20')	Orange	2,000 psi (138 bar)	34.08
1522	0.030" (0.75 mm)	3 m (10')	Natural	1,000 psi (69 bar)	17.04
1522G	0.030" (0.75 mm)	3 m (10')	Green	1,000 psi (69 bar)	17.04
★ 1520	0.030" (0.75 mm)	6 m (20')	Natural	1,000 psi (69 bar)	34.08
1520G	0.030" (0.75 mm)	6 m (20')	Green	1,000 psi (69 bar)	34.08
<b>FEP TUBING, 1/8" OD</b>					
★ 1521	0.062" (1.55 mm)	6 m (20')	Natural	500 psi (34 bar)	\$ 53.37
1521BL	0.062" (1.55 mm)	15 m (50')	Blue	500 psi (34 bar)	133.47
1521GL	0.062" (1.55 mm)	15 m (50')	Green	500 psi (34 bar)	133.47
1521ORL	0.062" (1.55 mm)	15 m (50')	Orange	500 psi (34 bar)	133.47
1521RL	0.062" (1.55 mm)	15 m (50')	Red	500 psi (34 bar)	133.47
1521YL	0.062" (1.55 mm)	15 m (50')	Yellow	500 psi (34 bar)	133.47
1523	0.062" (1.55 mm)	3 m (10')	Natural	500 psi (34 bar)	26.68
<b>FEP TUBING, 3/16" OD</b>					
1524	0.125" (3.20 mm)	6 m (20')	Natural	500 psi (34 bar)	\$ 64.88
1524L	0.125" (3.20 mm)	15 m (50')	Natural	500 psi (34 bar)	162.19
★ 1524XL	0.125" (3.20 mm)	30 m (100')	Natural	500 psi (34 bar)	275.35
1525	0.125" (3.20 mm)	3 m (10')	Natural	500 psi (34 bar)	32.43
<b>FEP TUBING, 1/4" OD</b>					
1651	0.156" (4.0 mm)	3 m (10')	Natural	250 psi (17 bar)	\$ 50.42
1651L	0.156" (4.0 mm)	15 m (50')	Natural	250 psi (17 bar)	252.15
1651XL	0.156" (4.0 mm)	30 m (100')	Natural	250 psi (17 bar)	429.39
1650	0.188" (4.80 mm)	3 m (10')	Natural	250 psi (17 bar)	50.42
1650L	0.188" (4.80 mm)	15 m (50')	Natural	250 psi (17 bar)	252.15
1650XL	0.188" (4.80 mm)	30 m (100')	Natural	250 psi (17 bar)	429.39
<b>FEP TUBING, 5/16" OD</b>					
1652	0.250" (6.35 mm)	3 m (10')	Natural	250 psi (17 bar)	\$ 53.04
1652L	0.250" (6.35 mm)	15 m (50')	Natural	250 psi (17 bar)	265.12
1652XL	0.250" (6.35 mm)	30 m (100')	Natural	250 psi (17 bar)	450.67
<b>FEP TUBING, 1.0 mm OD</b>					
1671	0.50 mm (0.020")	3 m (10')	Natural	500 psi (34 bar)	\$ 26.68
1671L	0.50 mm (0.020")	15 m (50')	Natural	500 psi (34 bar)	133.47
1671XL	0.50 mm (0.020")	30 m (100')	Natural	500 psi (34 bar)	227.07
<b>FEP TUBING, 2.0 mm OD</b>					
1673	1.0 mm (0.040")	3 m (10')	Natural	500 psi (34 bar)	\$ 26.68
1673L	1.0 mm (0.040")	15 m (50')	Natural	500 psi (34 bar)	133.47
1673XL	1.0 mm (0.040")	30 m (100')	Natural	500 psi (34 bar)	227.07
<b>FEP TUBING, 3.0 mm OD</b>					
1675	1.0 mm (0.040")	3 m (10')	Natural	500 psi (34 bar)	\$ 26.68
1675L	1.0 mm (0.040")	15 m (50')	Natural	500 psi (34 bar)	133.47
1675XL	1.0 mm (0.040")	30 m (100')	Natural	500 psi (34 bar)	227.07
1677	2.0 mm (0.080")	3 m (10')	Natural	500 psi (34 bar)	26.68
1677L	2.0 mm (0.080")	15 m (50')	Natural	500 psi (34 bar)	133.47
1677XL	2.0 mm (0.080")	30 m (100')	Natural	500 psi (34 bar)	227.07
<b>FEP TUBING, 4.0 mm OD</b>					
1679	3.0 mm (0.120")	3 m (10')	Natural	500 psi (34 bar)	\$ 32.43
1679L	3.0 mm (0.120")	15 m (50')	Natural	500 psi (34 bar)	162.19
1679XL	3.0 mm (0.120")	30 m (100')	Natural	500 psi (34 bar)	275.35

## DuPont® PFA Tubing

- ▶ 1/16" and 1/8" ODs available
- ▶ Excellent solvent resistance and low gas permeability

PFA (perfluoroalkoxyalkane) tubing offers excellent solvent resistance (virtually identical to FEP and PTFE) while adding several advantages. These include smoother surface texture, higher continuous service temperature and superior polymer purity. The recommended maximum operating temperature for our PFA tubing is 80 °C.



## DuPont High Purity PFA Tubing

- ▶ 1/16", 1/8", 3/16" or 1/4" outside diameter available
- ▶ PFA HP and PFA HP Plus Grades available
- ▶ Virtually contaminant free

PFA High Purity (HP) tubing offers all of the benefits of standard PFA tubing and more! This tubing is manufactured from a premium grade of PFA that is one of the most contaminant-free polymers available.

PFA HP Plus tubing is available in 1/16" and 1/8" OD sizes. This polymer grade has the same unsurpassed purity of PFA HP, with increased ability to withstand repeated flexing and improved resistance to stress cracking when exposed to aggressive fluorosurfactants. Furthermore, tubing made from PFA HP Plus offers even smoother, clearer walls than the standard PFA HP.

## 360 µm OD PFA HP Plus Tubing

Our capillary-sized tubing is manufactured from DuPont PFA HP Plus polymer. This tubing is available in the most commonly-used outside diameter for capillary tubing applications.

To cut this tubing to the length you need, we highly recommend our A-350 Polymer Tubing Cutter (see page 74).

Once this tubing is held in place by connecting fittings, extra care must be taken not to stretch the tubing, as this will likely cause dimensional changes in both the OD and the ID of the tubing.

## Specifications

### PFA Tubing Specifications

Tubing OD	OD Tolerances	Tubing ID	ID Tolerance
1/16"	±0.001" (25 µm)	All	±0.001" (25 µm)
1/8"	±0.003" (75 µm)	All	±0.003" (75 µm)

### High Purity PFA Tubing Specifications

Tubing OD	OD Tolerances	Tubing ID	ID Tolerance
1/16"	±0.001" (25 µm)	All	±0.001" (25 µm)
1/8"	±0.003" (75 µm)	All	±0.003" (75 µm)
3/16"	±0.003" (75 µm)	All	±0.003" (75 µm)
1/4"	±0.004 (0.10 mm)	All	±0.004 (0.10 mm)

### 360 µm OD PFA HP Tubing Specifications

Tubing OD	OD Tolerance	Tubing ID	ID Tolerance
360 µm	±0.0005" (12.5 µm)	All	±0.0005" (12.5 µm)



**Top Seller** SEE STARRED PRODUCTS

Part No.	ID	Length	Color	Max. Pressure	Price
<b>PFA TUBING, 1/16" OD</b>					
1500	0.020" (0.50 mm)	5' (1.5 m)	Natural	2,000 psi (138 bar)	\$ 9.65
1511	0.020" (0.50 mm)	10' (3 m)	Natural	2,000 psi (138 bar)	19.29
1512	0.020" (0.50 mm)	20' (6 m)	Natural	2,000 psi (138 bar)	38.63
1512L	0.020" (0.50 mm)	50' (15 m)	Natural	2,000 psi (138 bar)	96.77
1502	0.030" (0.75 mm)	5' (1.5 m)	Natural	1,000 psi (69 bar)	9.65
1513	0.030" (0.75 mm)	10' (3 m)	Natural	1,000 psi (69 bar)	19.29
1514	0.030" (0.75 mm)	20' (6 m)	Natural	1,000 psi (69 bar)	38.63
★ 1514L	0.030" (0.75 mm)	50' (15 m)	Natural	1,000 psi (69 bar)	96.77
1503	0.040" (1.0 mm)	5' (1.5 m)	Natural	500 psi (34 bar)	9.65
1504	0.040" (1.0 mm)	10' (3 m)	Natural	500 psi (34 bar)	19.29
1507	0.040" (1.0 mm)	20' (6 m)	Natural	500 psi (34 bar)	38.63
1507L	0.040" (1.0 mm)	50' (15 m)	Natural	500 psi (34 bar)	96.77
<b>PFA TUBING, 1/8" OD</b>					
1508	0.062" (1.55 mm)	10' (3 m)	Natural	500 psi (34 bar)	\$ 33.37
★ 1509	0.062" (1.55 mm)	20' (6 m)	Natural	500 psi (34 bar)	66.82
1509L	0.062" (1.55 mm)	50' (15 m)	Natural	500 psi (34 bar)	166.96
<b>PFA HP TUBING, 1/16" OD</b>					
1620	0.020" (0.50 mm)	5' (1.5 m)	Natural	2,000 psi (138 bar)	\$ 12.22
1621	0.020" (0.50 mm)	10' (3 m)	Natural	2,000 psi (138 bar)	24.38
1622	0.020" (0.50 mm)	20' (6 m)	Natural	2,000 psi (138 bar)	48.81
1622L	0.020" (0.50 mm)	50' (15 m)	Natural	2,000 psi (138 bar)	122.00
1630	0.030" (0.75 mm)	5' (1.5 m)	Natural	1,000 psi (69 bar)	12.22
1631	0.030" (0.75 mm)	10' (3 m)	Natural	1,000 psi (69 bar)	24.38
1632	0.030" (0.75 mm)	20' (6 m)	Natural	1,000 psi (69 bar)	48.81
1632L	0.030" (0.75 mm)	50' (15 m)	Natural	1,000 psi (69 bar)	122.00
<b>PFA HP TUBING, 1/8" OD</b>					
1640	0.062" (1.55 mm)	10' (3 m)	Natural	500 psi (34 bar)	\$ 38.47
1641	0.062" (1.55 mm)	20' (6 m)	Natural	500 psi (34 bar)	76.89
★ 1641L	0.062" (1.55 mm)	50' (15 m)	Natural	500 psi (34 bar)	192.20
<b>PFA HP TUBING, 3/16" OD</b>					
1642	0.125" (3.20 mm)	10' (3 m)	Natural	250 psi (17 bar)	\$ 42.53
1642L	0.125" (3.20 mm)	50' (15 m)	Natural	250 psi (17 bar)	212.66
1642XL	0.125" (3.20 mm)	100' (30 m)	Natural	250 psi (17 bar)	361.51
<b>PFA HP TUBING, 1/4" OD</b>					
1645	0.188" (4.80 mm)	10' (3 m)	Natural	250 psi (17 bar)	\$ 53.96
1645L	0.188" (4.80 mm)	50' (15 m)	Natural	250 psi (17 bar)	269.89
1645XL	0.188" (4.80 mm)	100' (30 m)	Natural	250 psi (17 bar)	458.81
<b>PFA HP PLUS TUBING, 1/16" OD</b>					
1900	0.010" (0.25 mm)	5' (1.5 m)	Natural	3,000 psi (207 bar)	\$ 14.63
1901	0.010" (0.25 mm)	10' (3 m)	Natural	3,000 psi (207 bar)	29.31
1902	0.010" (0.25 mm)	20' (6 m)	Natural	3,000 psi (207 bar)	58.61
1902L	0.010" (0.25 mm)	50' (15 m)	Natural	3,000 psi (207 bar)	146.53
1905	0.020" (0.50 mm)	5' (1.5 m)	Natural	2,000 psi (138 bar)	14.63
1906	0.020" (0.50 mm)	10' (3 m)	Natural	2,000 psi (138 bar)	29.31
1907	0.020" (0.50 mm)	20' (6 m)	Natural	2,000 psi (138 bar)	58.61
1907L	0.020" (0.50 mm)	50' (15 m)	Natural	2,000 psi (138 bar)	146.53
1910	0.030" (0.75 mm)	5' (1.5 m)	Natural	1,000 psi (69 bar)	14.63
1911	0.030" (0.75 mm)	10' (3 m)	Natural	1,000 psi (69 bar)	29.31
1912	0.030" (0.75 mm)	20' (6 m)	Natural	1,000 psi (69 bar)	58.61
1912L	0.030" (0.75 mm)	50' (15 m)	Natural	1,000 psi (69 bar)	146.53
<b>PFA HP PLUS TUBING, 1/8" OD</b>					
1920	0.062" (1.55 mm)	10' (3 m)	Natural	500 psi (34 bar)	\$ 46.13
1921	0.062" (1.55 mm)	20' (6 m)	Natural	500 psi (34 bar)	92.43
1921L	0.062" (1.55 mm)	50' (15 m)	Natural	500 psi (34 bar)	231.04
<b>PFA HP PLUS TUBING, 360 µm OD</b>					
1930	50 µm (0.002")	5' (1.5 m)	Natural	3,500 psi (241 bar)	\$ 22.72
1931	75 µm (0.003")	5' (1.5 m)	Natural	3,000 psi (207 bar)	22.72
1932	0.10 mm (0.004")	5' (1.5 m)	Natural	2,500 psi (172 bar)	22.72
1933	0.15 mm (0.006")	5' (1.5 m)	Natural	1,750 psi (121 bar)	22.72

## ETFE Tubing

- ▶ Excellent chemical resistance
- ▶ Holds pressure up to 4,000 psi (276 bar)
- ▶ 1/16", 1/8", or 1/4" outside diameter available
- ▶ Maximum continuous operating temperature: 80 °C

Upchurch Scientific® ETFE (ethylene-tetrafluoroethylene) tubing is an excellent fluoropolymer product that offers several benefits over tubing manufactured from PTFE, FEP or PFA. These benefits include enhanced pressure holding capabilities, increased mechanical stability and lower gas permeability.



## Halar® Tubing

- ▶ Excellent chemical resistance
- ▶ Good for radiation sterilization
- ▶ Maximum continuous operating temperature: 50 °C

As another member of the fluoropolymer family, Halar ECTFE (ethylene-chlorotrifluoroethylene) offers excellent chemical resistance coupled with mechanical strength superior to most other fluoropolymer products. Tubing made of Halar also outperforms many other fluoropolymer products in its ability to withstand radiation, making it attractive for in vitro medical applications.



## Specifications

### ETFE Tubing Specifications

Tubing OD	Tubing ID	OD/ID Tolerances
1/16" OD	0.010" (0.25 mm), 0.020" (0.50 mm), 0.030" (0.75 mm)	±0.001" (25 µm)
1/16" OD	0.040" (1.0 mm)	±0.002" (50 µm)
1/8" OD	All	±0.003" (75 µm)
1/4" OD	All	±0.004" (0.10 mm)

### Halar Tubing Specifications

Tubing OD	Tubing ID	OD/ID Tolerances
1/16"	All	±0.001" (25 µm)
1/8"	All	±0.003" (75 µm)



**Top Seller** SEE STARRED PRODUCTS

Part No.	ID	Length	Color	Max. Pressure	Price
<b>ETFE TUBING, 1/16" OD</b>					
1529	0.010" (0.25 mm)	5' (1.5 m)	Natural	4,000 psi (276 bar)	\$ 10.51
1529L	0.010" (0.25 mm)	50' (15 m)	Natural	4,000 psi (276 bar)	104.97
1529XL	0.010" (0.25 mm)	100' (30 m)	Natural	4,000 psi (276 bar)	178.58
1516	0.020" (0.50 mm)	5' (1.5 m)	Natural	3,000 psi (207 bar)	10.51
1516L	0.020" (0.50 mm)	50' (15 m)	Natural	3,000 psi (207 bar)	104.97
★ 1516XL	0.020" (0.50 mm)	100' (30 m)	Natural	3,000 psi (207 bar)	178.58
1528	0.030" (0.75 mm)	5' (1.5 m)	Natural	2,000 psi (138 bar)	10.51
1528L	0.030" (0.75 mm)	50' (15 m)	Natural	2,000 psi (138 bar)	104.97
★ 1528XL	0.030" (0.75 mm)	100' (30 m)	Natural	2,000 psi (138 bar)	178.58
1517	0.040" (1.00 mm)	5' (1.5 m)	Natural	500 psi (34 bar)	10.51
1517L	0.040" (1.00 mm)	50' (15 m)	Natural	500 psi (34 bar)	104.97
1517XL	0.040" (1.00 mm)	100' (30 m)	Natural	500 psi (34 bar)	178.58
<b>ETFE TUBING, 1/8" OD</b>					
1515	0.062" (1.55 mm)	5' (1.5 m)	Black	1,000 psi (69 bar)	\$ 15.91
1515L	0.062" (1.55 mm)	50' (15 m)	Black	1,000 psi (69 bar)	158.80
1515XL	0.062" (1.55 mm)	100' (30 m)	Black	1,000 psi (69 bar)	269.89
★ 1530	0.062" (1.55 mm)	5' (1.5 m)	Natural	1,000 psi (69 bar)	15.91
1530L	0.062" (1.55 mm)	50' (15 m)	Natural	1,000 psi (69 bar)	158.80
★ 1530XL	0.062" (1.55 mm)	100' (30 m)	Natural	1,000 psi (69 bar)	269.89
1648	0.093" (2.40 mm)	5' (1.5 m)	Natural	500 psi (34 bar)	15.91
1648L	0.093" (2.40 mm)	50' (15 m)	Natural	500 psi (34 bar)	158.80
★ 1648XL	0.093" (2.40 mm)	100' (30 m)	Natural	500 psi (34 bar)	269.89
<b>ETFE TUBING, 1/4" OD</b>					
1647	0.188" (4.80 mm)	5' (1.5 m)	Natural	250 psi (17 bar)	\$ 45.76
1647L	0.188" (4.80 mm)	50' (15 m)	Natural	250 psi (17 bar)	228.90
1647XL	0.188" (4.80 mm)	100' (30 m)	Natural	250 psi (17 bar)	395.22
<b>HALAR TUBING, 1/16" OD</b>					
4010	0.010" (0.25 mm)	5' (1.5 m)	Natural	6,000 psi (414 bar)	\$ 10.51
4010L	0.010" (0.25 mm)	50' (15 m)	Natural	6,000 psi (414 bar)	104.97
4010XL	0.010" (0.25 mm)	100' (30 m)	Natural	6,000 psi (414 bar)	178.58
4020	0.020" (0.50 mm)	5' (1.5 m)	Natural	3,500 psi (241 bar)	10.51
4020L	0.020" (0.50 mm)	50' (15 m)	Natural	3,500 psi (241 bar)	104.97
4020XL	0.020" (0.50 mm)	100' (30 m)	Natural	3,500 psi (241 bar)	178.58
4030	0.030" (0.75 mm)	5' (1.5 m)	Natural	3,000 psi (207 bar)	10.51
4030L	0.030" (0.75 mm)	50' (15 m)	Natural	3,000 psi (207 bar)	104.97
★ 4030XL	0.030" (0.75 mm)	100' (30 m)	Natural	3,000 psi (207 bar)	178.58
<b>HALAR TUBING, 1/8" OD</b>					
4000	0.062" (1.55 mm)	5' (1.5 m)	Natural	2,500 psi (172 bar)	\$ 15.91
4000L	0.062" (1.55 mm)	50' (15 m)	Natural	2,500 psi (172 bar)	158.80
4000XL	0.062" (1.55 mm)	100' (30 m)	Natural	2,500 psi (172 bar)	269.89

### Fused Silica Tubing Cutters

We offer a precision cutter for fused silica tubing — SGT's Shortix™ Cutter (FS-315). This cutter ensures clean, trouble-free cutting of fused silica tubing, providing better cuts than any other product on the market. It also includes a built-in magnifying glass to examine the cut tubing ends. Order the FS-315-02 Maintenance Kit, as needed, to replace a worn or damaged cutting wheel.



**FS-315**  
for fused silica tubing

When using traditional fused silica tubing cutters, only a small part of the tubing wall is scratched, then the tubing is snapped or pulled in two, often resulting in a jagged, uneven cut. With a Shortix Cutter, a clean cut is made every time, regardless of skill or experience, as the cut is made by rotating a diamond blade around the entire circumference of the tubing.

*Please Note: The FS-315 Fused Silica Tubing Cutters are designed to cut only tubing with ODs of 350 μm – 780 μm and IDs of 100 μm – 350 μm.*

### Polymer Tubing Cutters

► For 1/16", 1/8", 3/16", 1/4" and 5/16" OD tubing

A flat, 90°, burr-free cut is difficult to obtain with most commercial polymer tubing cutters. Upchurch Scientific® has designed several tubing cutters specifically to cut polymer tubing. This line of tubing cutters includes a standard cutter for 1/16" and 1/8" OD tubing (A-327), and another for large bore tubing (A-329). Each has guide holes to ensure precise cutting. These cutters are durable, reliable and easy to operate. Five replacement blades are included with each cutter.



**A-327**  
for 1/16" and 1/8" OD tubing

**A-329**  
for 3/16" - 5/16" OD tubing

#### Note

- The A-350 Capillary Polymer Tubing Cutter can be used to cut tubing OD sizes other than 360 μm, 510 μm and 1/32". Simply use the proper NanoTight™ Tubing Sleeve found on page 17. Please note, however, that these sleeves are shorter than those listed on this page, and therefore will last through fewer cuts.
- Our tubing cutters are material specific: the A-327, A-329 and A-350 should only be used to cut polymer tubing, where as the FS-315 should only be used to cut fused silica tubing.

### Capillary Polymer Tubing Cutter

The Upchurch Scientific A-350 Cutter is designed to cut capillary-sized polymer tubing. The cutter makes clean, perpendicular cuts without collapsing thin capillary walls. A set of ten tubing sleeves, required for cutting, are included with each cutter, along with five replacement blades. The included tubing sleeves are for cutting 360 μm OD polymer capillary tubing. Alternative sleeves are available for cutting 510 μm and 1/32" OD tubing. All tubing sleeves are 2" long and are made of DuPont® FEP.



**A-350**  
for capillary polymer tubing

### Polymer Tubing Cutter for 2.0 mm OD Tubing

Upchurch Scientific introduces a new tubing cutter specifically for cutting 2.0 mm OD polymer tubing. The A-370 tubing cutter is designed to cut in a similar method to the A-350 capillary polymer tubing cutter. The tubing slides through the cutter and the knob is rotated to spin the tubing as the razor blade circumscribes the tubing, providing a very clean, perpendicular cut.



Part No.	Description	Qty.	Price
<b>FUSED SILICA TUBING CUTTERS</b>			
<b>FS-315</b>	Shortix Fused Silica Tubing Cutter	ea.	\$ 282.61
<b>CAPILLARY POLYMER TUBING CUTTER</b>			
★ <b>A-350</b>	Capillary Polymer Tubing Cutter* for 360 μm – 1/32" OD tubing Includes (1) F-262x 10-pack of sleeves and (1) M-438-03 wrench	ea.	\$ 103.15
<b>F-262x</b>	Replacement Sleeves for A-350, 0.0155" ID, Green, for cutting 360 μm OD tubing	10-pk	21.48
<b>F-264x</b>	Alternative Sleeves for A-350, 0.021" ID, Natural, for cutting 510 μm OD tubing	10-pk	21.48
<b>F-267Bx</b>	Alternative Sleeves for A-350, 0.033" ID, Blue, for cutting 1/32" OD tubing	10-pk	21.48
★ <b>A-327</b>	Standard Polymer Tubing Cutter* for 1/16" and 1/8" OD tubing	ea.	20.08
<b>A-329</b>	Large Bore Polymer Tubing Cutter* for 3/16"– 5/16" OD tubing	ea.	20.08
<b>A-328</b>	Replacement Blades for A-350, A-370, A-327 and A-329	5-pk	5.25
<b>A-370</b>	Polymer Tubing Cutter for 2.0 mm OD tubing	ea.	127.50

\* Includes (1) A-328 5-pack of replacement blades

						
TUBING	TYGON® ST	TYGON LFL	TYGON 2001	TYGON MHLL	TYGON F-4040-A	TYGON MH 2075
Page	78	79	80	81	82	83
<b>Description</b>	<p>The inexpensive all-round tubing for general laboratory applications.</p> <ul style="list-style-type: none"> <li>• Transparent</li> <li>• Resistant to almost all inorganic chemicals</li> <li>• Tasteless</li> <li>• Smooth polished inner wall</li> <li>• Low gas permeability</li> <li>• Non-aging and non-oxidizing</li> <li>• High dielectric constant</li> </ul>	<p>The tubing with the longest service-life of any clear Tygon tubing.</p> <ul style="list-style-type: none"> <li>• Transparent</li> <li>• Broad chemical resistance</li> <li>• Tasteless</li> <li>• Extremely low particulate spallation</li> <li>• Meets USP Class VI and FDA criteria</li> <li>• Non-aging</li> <li>• High dielectric constant</li> </ul>	<p>The transparent, plasticiser-free tubing with superior pump-life. Especially designed for MEK and other aggressive solvents.</p> <ul style="list-style-type: none"> <li>• Plasticizer and oil-free</li> <li>• Smooth inner-bore</li> <li>• Low sorption maintains fluid and tube integrity</li> <li>• Does not impart anything into the pumping medium</li> <li>• No release of hazardous materials when properly incinerated</li> </ul>	<p>Chemically resistant to Acetone, MEK and other aggressive solvents. Long life tubing</p> <ul style="list-style-type: none"> <li>• Plasticiser-free</li> <li>• Smooth inner-bore</li> <li>• Low sorption maintains fluid integrity</li> <li>• Minimal adhesion and diffusion</li> <li>• Suitable for MEK, Acetone and other corrosive solvents</li> <li>• Long life tubing</li> </ul>	<p>The special tubing for hydrocarbons, petroleum products and distillates.</p> <ul style="list-style-type: none"> <li>• Specially formulated to transport hydrocarbons, petroleum products and distillates</li> <li>• Ideal for gasoline, kerosene, heating oils, cutting liquids and coolants based on glycols</li> <li>• High dielectric constant</li> <li>• Low gas permeability</li> </ul>	<p>The environmental-friendly tubing especially designed for solvents.</p> <ul style="list-style-type: none"> <li>• No additives</li> <li>• No plasticizers</li> <li>• Suitable for methyl ethyl ketone (MEK), acetone and other corrosive solvents</li> <li>• Extremely smooth inner surface</li> <li>• Easily disposable</li> </ul>
<b>Specifications</b>						
<b>OD (outside diameter)</b>	0.16 – 0.88" (4.0 – 22.3 mm)	0.19 – 0.75" (4.8 – 19.1 mm)	0.19 – 0.88" (4.8 – 22.3 mm)	0.09 – 0.18" (2.22 – 4.63 mm)	0.19 – 0.75" (4.8 – 19.1 mm)	0.19 – 0.88" (4.8 – 22.3 mm)
<b>ID (inside diameter)</b>	0.03 – 0.61" (0.8 – 15.9 mm)	0.06 – 0.5" (1.6 – 12.7 mm)	0.06 – 0.61" (1.6 – 15.9 mm)	0.01 – 0.1" (0.38 – 2.79 mm)	0.06 – 0.5" (1.6 – 12.7 mm)	0.06 – 0.61" (1.6 – 15.9 mm)
<b>Operating Temp</b>	-50 to 74 °C	-50 to 74 °C	-73 to 57 °C	-70 to 74 °C	-37 to 74 °C	-70 to 52 °C
<b>Certification(s)</b>	FDA 21 CFR 175.300	FDA 21 CFR 175.300; US Pharmacopoeia Class VI	FDA 21 CFR 177.2600; FDA Approved for contact with foods	FDA 21 CFR 177.2600; US Pharmacopoeia Class VI	None	FDA 21 CFR 177.2600; REACH Compliant; US Pharmacopoeia Class VI
<b>Chemical Resistance</b>						
<b>Acids</b>	Good	Good	Excellent	Excellent	Limited	Excellent
<b>Alkaline Solutions</b>	Good	Good	Excellent	Excellent	Not Recommended	Excellent
<b>Solvents</b>	Not Recommended	Not Recommended	Good	Excellent	Not Recommended	Excellent
<b>Pressure</b>	Fair	Good	Good	Not Recommended	Good	Not Recommended
<b>Vacuum</b>	Good	Good	Good	Good	Good	Good
<b>Viscous Media</b>	Excellent	Excellent	Excellent	Good	Excellent	Good
<b>Sterile Media</b>	Limited	Limited	Good	Good	Limited	Good
<b>Gas Permeability (at 25 °C)*</b>						
<b>CO<sub>2</sub></b>	360	563	1140	4900	100	4840
<b>H<sub>2</sub></b>	—	—	—	—	—	—
<b>O<sub>2</sub></b>	80	124	76	1000	22	980
<b>N<sub>2</sub></b>	40	67	190	350	12	350

\* Permeability Coefficient =  $\frac{\text{Amount of Gas (cm}^3\text{)} \times \text{tubing wall thickness (cm)}}{\text{Surface Area of tubing ID (cm}^2\text{)} \times \text{time (sec)} \times \text{pressure drop across tubing wall (cm Hg)}} \times 10^{-10}$

TUBING							
	TYGON® SI 3350	NORPRENE® A-60-G	PHARMED® ISMAPRENE	SILICON PEROXIDE	FLURAN® F-5500-A	GORE™ STYLE 100	GORE STYLE 100CR
Page	84	85	86	87	88	89	89
Description	<p>The platinum-cured silicone tubing with an ultra-smooth inner surface for sanitary transfer of sensitive fluids.</p> <ul style="list-style-type: none"> <li>• Can be autoclaved with steam</li> <li>• Excellent biological compatibility</li> <li>• Ultra-smooth inner-bore reduces potential for particle entrapment</li> <li>• Lower level of protein binding</li> <li>• Entirely non-toxic, non-hemolytic and non-pyrogenic</li> <li>• Weather, ozone, sunlight and radiation resistant</li> <li>• Resistant to fungus</li> <li>• Odorless</li> </ul>	<p>The high performance tubing for industrial use.</p> <ul style="list-style-type: none"> <li>• Offers longest service-life with good flow consistency</li> <li>• Good resistance to acids and alkaline chemicals</li> <li>• Superior weathering</li> <li>• Abrasion resistant</li> <li>• Non-aging and non-oxidizing</li> <li>• Outstanding flexural fatigue resistance</li> <li>• Low gas permeability versus rubber tubing</li> <li>• Ozone (300 pphm) and UV light resistant</li> <li>• Ideal for use in vacuum system</li> </ul>	<p>The ideal tubing for pharmaceutical and medical applications, and for foodstuffs.</p> <ul style="list-style-type: none"> <li>• Recommended for cell cultures and tissue</li> <li>• Ideal for production filtration, fermentation and bioreactor process lines</li> <li>• Very long service-life</li> <li>• Non-toxic and non-hemolytic</li> <li>• Impermeable to normal light and UV-radiation</li> <li>• Appropriate for medical products and foodstuffs</li> <li>• Low particulate spallation</li> <li>• Can be autoclaved repeatedly</li> <li>• Withstands repeated CIP and SIP cleaning and sterilization</li> <li>• Meets USP class VI, FDA and NSF criteria</li> </ul>	<p>Silicone tubing blended with organic peroxide for biological applications.</p> <ul style="list-style-type: none"> <li>• Can be autoclaved with steam</li> <li>• Excellent biological compatibility</li> <li>• Greater physical compression capability</li> <li>• Not prone to mold</li> <li>• Non-toxic</li> <li>• Waterproof and resistant to ozone, radiation and sunlight</li> <li>• Resistant to fungus</li> <li>• Odorless</li> </ul>	<p>The special tubing for concentrated acids and corrosive solvents.</p> <ul style="list-style-type: none"> <li>• High chemical resistance</li> <li>• Low gas permeability</li> <li>• Wide temperature range</li> </ul>	<p>Long life under pressure, excellent flow stability, no break-in period required, spallation-free, and excellent biocompatibility.</p> <ul style="list-style-type: none"> <li>• Virtually eliminates spallation</li> <li>• Lasts 18 times longer than silicone tubing</li> <li>• Operates at pressures as high as 60 psi (4.2 bar)</li> <li>• Superior burst strength approaching 360 psi (25 bar)</li> <li>• Extremely stable flow rate over time</li> </ul>	<p>With excellent chemical resistance, GORE Style 100CR Peristaltic Pump Tubes handle nearly all aggressive chemicals, including organic solvents such as Methyl ethyl ketone (MEK), Toluene, and Acetone</p> <ul style="list-style-type: none"> <li>• The longest-lasting tubing for increased productivity</li> <li>• The tubing with significantly higher burst resistance</li> <li>• High purity reduces contamination</li> <li>• Lowest solvent swell</li> </ul>

Specifications							
<b>OD (outside diameter)</b>	0.16 – 1.3" (4.0 – 33.4 mm)	0.16 – 0.9" (4.0 – 22.3 mm)	0.16 – 1.3" (4.0 – 33.4 mm)	0.16 – 1.3" (4.0 – 33.4 mm)	0.16 – 0.6" (4.0 – 15.9 mm)	0.17 – 1.37" (4.4 – 34.9 mm)	0.17 – 1.37" (4.4 – 34.9 mm)
<b>ID (inside diameter)</b>	0.03 – 1" (0.8 – 25.4 mm)	0.03 – 0.6" (0.8 – 15.9 mm)	0.03 – 1" (0.8 – 25.4 mm)	0.03 – 1" (0.8 – 25.4 mm)	0.03 – 0.4" (0.8 – 9.5 mm)	0.06 – 1" (1.6 – 25.4 mm)	0.06 – 1" (1.6 – 25.4 mm)
<b>Operating Temp</b>	-60 to +200 °C	-60 to 135 °C	-60 to 135 °C	-51 to 238 °C	-32 to 204 °C	-40 to 150 °C	-80 to 200 °C
<b>Certification(s)</b>	FDA 21 CFR, 177.2600, Also exceeds 3A sanitary standards; US Pharmacopoea XXIII Cl.VI;	None	FDA 21 CFR 177.2600; US Pharmacopoea Class VI, NSF listed (Standard 51)	FDA 21 CFR 177.2600; US Pharmacopoea XXIII Cl.VI	GMP	FDA 21 CFR 177.2600; US Pharmacopoea Class VI	FDA 21 CFR 177.1550; US Pharmacopoea Class VI
Chemical Resistance							
<b>Acids</b>	Limited	Excellent	Good	Limited	Excellent	Not Recommended	Excellent
<b>Alkaline Solutions</b>	Limited	Excellent	Good	Good	Excellent	Not Recommended	Excellent
<b>Solvents</b>	Limited	Not Recommended	Not Recommended	Not Recommended	Limited	Not Recommended	Excellent
<b>Pressure</b>	Not Recommended	Not Recommended	Not Recommended	Not Recommended	Not Recommended	Excellent	Good
<b>Vacuum</b>	Good	Good	Excellent	Good	Good	Good	Good
<b>Viscous Media</b>	Fair	Excellent	Good	Fair	Good	Good	Excellent
<b>Sterile Media</b>	Excellent	Not Recommended	Excellent	Excellent	Fair	Excellent	Good
Permeability (at 25 °C)							
<b>CO<sub>2</sub></b>	25147	1200	1200	25147	38	20132	76
<b>H<sub>2</sub></b>	—	—	—	—	—	6579	—
<b>O<sub>2</sub></b>	4715	200	200	4715	14	7961	—
<b>N<sub>2</sub></b>	2284	80	80	2284	5	2763	4.3

## Peristaltic Pumps and Tubing

The pumps presented on pages 94 – 108 require peristaltic tubing to operate. Flow rate of a given fluid through a peristaltic tubing pump depends on two variables:

1. The speed of the pump, measured in revolutions per minute (rpm)
2. The volume held with the internal diameter (ID) of the selected tubing

### Variable Speed Pump Flow Rates

For a variable speed pump, such as the products on pages 94 – 100, 112 – 115, and 119 – 118, the flow rate of a channel can be changed by varying the pump rpm, or by using tubing with different IDs, or a combination of both.

### Fixed Speed Pump Flow Rates

For a fixed speed pump, such as the MS/CA line on page 108, the only variable is the tubing ID. Therefore, to change the flow rate of a fixed speed pump channel, the operator must use tubing with a different ID.

Single-channel and multichannel peristaltic tubing pumps are available in this catalog. The number of channels refers to how many pieces of tubing that can be used simultaneously. Tubing with different IDs can be used in each channel to deliver varying flow rates at any given pump speed.

## Ordering your Pump and Tubing

Follow these steps to complete your Ismatec® peristaltic tubing pump order:

1. Select the pump for your application from pages 91 – 124, determined by the requirements of your fluid delivery task(s):
  - a. Level of accuracy
  - b. Fluid streams (# of channels)
  - c. Flow rate range(s)
  - d. Need for constant flow, discrete dispensing, or both
  - e. Need for variable speed
  - f. Need for automation/programmability
2. Note whether the selected pump requires 2-stop, 3-stop or standard tubing.
3. Review the tubing properties tables on pages 63, 70, 75 and 76 and select the tubing material best suited for your application.
4. Review the page that contains information and options for the tubing material you have selected.
5. Identify the correct part number for the tubing you need, based upon two factors: a) if your pump requires tubing with stops or not, and if so how many; and b) the correct inner diameter and wall thickness for the model pump you are using.
6. If required, order extension tubing that corresponds as closely as possible to the tubing material and ID of your 2-stop or 3-stop tubing.

## Related Products

Connectors and adapters for peristaltic tubing are on pages 59, 60 and 61.

## Tygon® ST Tubing

► The Tygon blend of choice for general laboratory applications

Tygon ST offers an all-around, inexpensive option for general laboratory applications. Featuring transparent walls and low gas permeability – and with many different sizes from which to choose – this tubing material option is the option of choice for many less-critical applications. To determine the expected flow rates related to the tubing inner diameters, see the technical specifications for your pump model, listed here in this catalog or in your pump’s operating manual. (Please Note: The low overall lifetime of this material will require tubing to be replaced frequently. For a longer life version of Tygon ST, consider Tygon LFL. Information for this material can be found on page 79.)

### Specifications

#### Tygon ST R-3603/R-3607 Tubing

**Special Properties** The inexpensive all-round tubing for general laboratory applications

**Advantages**

- Transparent
- Resistant to almost all inorganic chemicals
- Tasteless
- Smooth polished inner wall
- Low gas permeability
- Non-aging and non-oxidizing
- High dielectric constant

**Limitations**

- Potential leaching of plasticizers
- Short service-life

**Physical Properties**

- Thermoplastic
- PVC-based material with plasticizer
- Flexible, firm, transparent

**Service Temperature Range**

-50 °C to +74 °C (-58 °F to +165 °F)

**Applications**

Acids	Good
Alkaline solutions	Good
Solvents	Not recommended
Pressure	Fair
Vacuum	Good
Viscous media	Excellent
Sterile media	Limited

**Complies with the Following Standards**

FDA 21 CFR 175.300

**Sterilization**

Autoclavable with steam, 30 minutes at 1 bar (15 psi) and 121 °C (250 °F); tubing will appear milky. Gas sterilization with Ethylene oxide. **Not recommended for sterilization with radiation.**

**Permeability**

	CO <sub>2</sub>	360	$\frac{\text{Volume of gas [cm}^3\text{]} \times \text{wall thickness [mm]}}{\text{Area of tubing ID [cm}^2\text{]} \times \text{time [sec]} \times \text{pressure drop across tubing wall [cm Hg]}} \times 10^{-10}$
	O <sub>2</sub>	80	
	N <sub>2</sub>	40	

**Odor and taste**

None

**Toxicity**

Non-toxic

**Tubing**

at 0 bar life 35 hrs

at 0.7 bar 30 hrs

Part No.	ID	OD	Length	Price
----------	----	----	--------	-------

#### STANDARD TUBING

##### Tygon ST Tubing, 1/16" (1.6 mm) WT

MF0001A	1/32" (0.8 mm)	5/32" (4 mm)	49.2' (15 m)	\$ 34.48
MF0028A	1/16" (1.6 mm)	3/16" (4.8 mm)	49.2' (15 m)	37.23
SC0691	1/4" (2.4 mm)	7/32" (5.6 mm)	49.2' (15 m)	44.47
MF0030	1/8" (3.2 mm)	1/4" (6.4 mm)	49.2' (15 m)	56.30
SC0462	5/32" (4 mm)	9/32" (7.2 mm)	49.2' (15 m)	70.79
SC0379	3/16" (4.8 mm)	5/16" (8 mm)	49.2' (15 m)	81.70
MF0031	1/4" (6.4 mm)	3/8" (9.6 mm)	49.2' (15 m)	91.70
MF0032	5/16" (8 mm)	7/16" (11.2 mm)	49.2' (15 m)	110.77
SC0383A	3/8" (9.5 mm)	1/2" (12.7 mm)	49.2' (15 m)	134.33
SC0384	7/16" (11.1 mm)	9/16" (14.3 mm)	49.2' (15 m)	147.66

##### Tygon ST Tubing, 1/4" (2.4 mm) WT

MF0029A	3/16" (4.8 mm)	3/8" (9.6 mm)	49.2' (15 m)	\$ 124.34
MF0033A	1/4" (6.4 mm)	7/16" (11.2 mm)	49.2' (15 m)	151.57
SC0502	5/16" (8 mm)	1/2" (12.8 mm)	49.2' (15 m)	167.08
SC0503A	3/8" (9.5 mm)	9/16" (14.3 mm)	49.2' (15 m)	159.35
SC0504	7/16" (11.1 mm)	5/8" (15.9 mm)	49.2' (15 m)	189.72
SC0505	1/2" (12.7 mm)	11/16" (17.5 mm)	49.2' (15 m)	219.71
SC0506	5/8" (15.9 mm)	13/16" (20.7 mm)	49.2' (15 m)	267.85

Part No.	ID	OD	Length	Price
----------	----	----	--------	-------

#### STANDARD TUBING

##### Tygon ST Tubing, 1/8" (3.2 mm) WT

SC0694	3/16" (4.8 mm)	7/16" (11.2 mm)	49.2' (15 m)	\$ 177.07
SC0380	1/4" (6.4 mm)	1/2" (12.8 mm)	49.2' (15 m)	195.23
SC0535	5/16" (8 mm)	9/16" (14.4 mm)	49.2' (15 m)	202.47
SC0381	3/8" (9.5 mm)	5/8" (15.9 mm)	49.2' (15 m)	247.86
SC0534	7/16" (11.1 mm)	11/16" (17.5 mm)	49.2' (15 m)	266.93
SC0382	1/2" (12.7 mm)	5/8" (15.9 mm)	49.2' (15 m)	297.74
SC0695	5/8" (15.9 mm)	7/8" (22.3 mm)	49.2' (15 m)	350.37

#### STOPPER TUBING

Part No.	ID	OD	Color	Length	Price
----------	----	----	-------	--------	-------

##### Tygon ST 2-Stop Tubing for CA Cassettes, 0.91 mm WT (12-pk)

SC0188	0.005" (0.13 mm)	0.076" (1.95 mm)	orange-black	15.75" (400 mm)	\$ 21.83
SC0001	0.007" (0.19 mm)	0.079" (2.01 mm)	orange-red	15.75" (400 mm)	22.75
SC0002	0.009" (0.25 mm)	0.815" (2.07 mm)	orange-blue	15.75" (400 mm)	22.75
SC0003	0.014" (0.38 mm)	0.086" (2.2 mm)	orange-green	15.75" (400 mm)	22.75
SC0004	0.017" (0.44 mm)	0.088" (2.26 mm)	green-yellow	15.75" (400 mm)	22.75
SC0005	0.02" (0.51 mm)	0.091" (2.33 mm)	orange-yellow	15.75" (400 mm)	22.75
SC0006	0.022" (0.57 mm)	0.094" (2.39 mm)	white-yellow	15.75" (400 mm)	22.75
SC0007	0.025" (0.64 mm)	0.096" (2.46 mm)	orange-white	15.75" (400 mm)	22.75

##### Tygon ST 2-Stop Tubing for CA Cassettes, 0.86 mm WT (12-pk)

SC0008	0.029" (0.76 mm)	0.097" (2.48 mm)	black-black	15.75" (400 mm)	\$ 22.75
SC0009	0.035" (0.89 mm)	0.102" (2.61 mm)	orange-orange	15.75" (400 mm)	22.75
SC0010	0.037" (0.95 mm)	0.105" (2.67 mm)	white-black	15.75" (400 mm)	22.75
SC0011	0.04" (1.02 mm)	0.108" (2.74 mm)	white-white	15.75" (400 mm)	22.75
SC0012	0.436" (1.09 mm)	0.110" (2.81 mm)	white-red	15.75" (400 mm)	22.75
SC0013	0.044" (1.14 mm)	0.112" (2.86 mm)	red-red	15.75" (400 mm)	22.75
SC0014	0.048" (1.22 mm)	0.115" (2.94 mm)	red-grey	15.75" (400 mm)	22.75
SC0015	0.051" (1.3 mm)	0.118" (3.02 mm)	grey-grey	15.75" (400 mm)	22.75
SC0016	0.055" (1.42 mm)	0.123" (3.14 mm)	yellow-yellow	15.75" (400 mm)	22.75
SC0017	0.059" (1.52 mm)	0.127" (3.24 mm)	yellow-blue	15.75" (400 mm)	22.75
SC0018	0.064" (1.65 mm)	0.132" (3.37 mm)	blue-blue	15.75" (400 mm)	22.75
SC0019	0.068" (1.75 mm)	0.136" (3.47 mm)	blue-green	15.75" (400 mm)	22.75
SC0020	0.072" (1.85 mm)	0.140" (3.57 mm)	green-green	15.75" (400 mm)	22.75
SC0021	0.081" (2.06 mm)	0.148" (3.78 mm)	purple-purple	15.75" (400 mm)	22.75
SC0022	0.09" (2.29 mm)	0.157" (4.01 mm)	purple-black	15.75" (400 mm)	22.75
SC0023	0.1" (2.54 mm)	0.167" (4.26 mm)	purple-orange	15.75" (400 mm)	22.75
SC0024	0.109" (2.79 mm)	0.178" (4.51 mm)	purple-white	15.75" (400 mm)	22.75
SC0222	0.125" (3.17 mm)	0.192" (4.89 mm)	black-white	15.75" (400 mm)	21.83

##### Tygon ST 3-Stop Tubing for MS/CA Cassettes, 0.91 mm WT (12-pk)

SC0189	0.005" (0.13 mm)	0.076" (1.95 mm)	orange-black	15.75" (400 mm)	\$ 29.99
SC0049	0.007" (0.19 mm)	0.079" (2.01 mm)	orange-red	15.75" (400 mm)	29.99
SC0050	0.009" (0.25 mm)	0.815" (2.07 mm)	orange-blue	15.75" (400 mm)	29.99
SC0051	0.014" (0.38 mm)	0.086" (2.2 mm)	orange-green	15.75" (400 mm)	29.99
SC0052A	0.017" (0.44 mm)	0.088" (2.26 mm)	green-yellow	15.75" (400 mm)	29.99
SC0053	0.02" (0.51 mm)	0.091" (2.33 mm)	orange-yellow	15.75" (400 mm)	29.99
SC0054A	0.022" (0.57 mm)	0.094" (2.39 mm)	white-yellow	15.75" (400 mm)	29.99
SC0055	0.025" (0.64 mm)	0.096" (2.46 mm)	orange-white	15.75" (400 mm)	29.99

##### Tygon ST 3-Stop Tubing for MS/CA Cassettes, 0.86 mm WT (12-pk)

SC0056	0.029" (0.76 mm)	0.097" (2.48 mm)	black-black	15.75" (400 mm)	\$ 29.99
SC0057	0.035" (0.89 mm)	0.102" (2.61 mm)	orange-orange	15.75" (400 mm)	29.99
SC0058	0.037" (0.95 mm)	0.105" (2.67 mm)	white-black	15.75" (400 mm)	29.99
SC0059	0.04" (1.02 mm)	0.108" (2.74 mm)	white-white	15.75" (400 mm)	29.99
SC0060A	0.0436" (1.09 mm)	0.110" (2.81 mm)	white-red	15.75" (400 mm)	29.99
SC0061	0.044" (1.14 mm)	0.112" (2.86 mm)	red-red	15.75" (400 mm)	29.99
SC0062	0.048" (1.22 mm)	0.115" (2.94 mm)	red-grey	15.75" (400 mm)	29.99
SC0063	0.051" (1.3 mm)	0.118" (3.02 mm)	grey-grey	15.75" (400 mm)	29.99
SC0064	0.055" (1.42 mm)	0.123" (3.14 mm)	yellow-yellow	15.75" (400 mm)	29.99
SC0065	0.059" (1.52 mm)	0.127" (3.24 mm)	yellow-blue	15.75" (400 mm)	29.99
SC0066	0.064" (1.65 mm)	0.132" (3.37 mm)	blue-blue	15.75" (400 mm)	29.99
SC0067A	0.068" (1.75 mm)	0.136" (3.47 mm)	blue-green	15.75" (400 mm)	29.99
SC0068	0.072" (1.85 mm)	0.140" (3.57 mm)	green-green	15.75" (400 mm)	29.99
SC0069	0.081" (2.06 mm)	0.148" (3.78 mm)	purple-purple	15.75" (400 mm)	29.99
SC0070A	0.09" (2.29 mm)	0.157" (4.01 mm)	purple-black	15.75" (400 mm)	29.99
SC0071	0.1" (2.54 mm)	0.167" (4.26 mm)	purple-orange	15.75" (400 mm)	29.99
SC0072	0.109" (2.79 mm)	0.178" (4.51 mm)	purple-white	15.75" (400 mm)	29.99
SC0224	0.125" (3.17 mm)	0.192" (4.89 mm)	black-white	15.75" (400 mm)	29.99

## Tygon® LFL Tubing

- ▶ Longest service life of any clear Tygon tubing material
- ▶ Excellent choice where transparency and good chemical resistance is needed

Tygon LFL tubing is available in a broad range of sizes for use throughout our pump product line. Its good chemical resistance coupled with its durability makes it an excellent choice in those applications where longer-life tubing is desired (i.e., where tubes are not disposed of frequently).

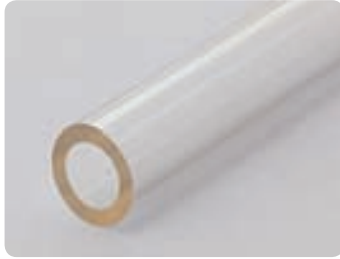

In many cases, this tubing can withstand system pressures that are in excess of most peristaltic pumps' abilities, providing built-in safety precautions for your system flow path.

Choose tubing without stops for use with most single-channel pumps. (NOTE: Ensure the wall thickness of the tubing you have selected matches the requirements for the pump you are using.) Choose the 2-stop or 3-stop tubing for use with the versions of our pumps that incorporate cassettes into the pumphead design.

## Specifications

### Tygon LFL Long Flex Life Tubing

<b>Special Properties</b>	The tubing with the longest service-life of any clear Tygon tubing.															
<b>Advantages</b>	<ul style="list-style-type: none"> <li>• Transparent</li> <li>• Broad chemical resistance</li> <li>• Tasteless</li> <li>• Extremely low particulate spallation</li> <li>• Meets USP Class VI and FDA criteria</li> <li>• Non-aging</li> <li>• High dielectric constant</li> </ul>															
<b>Limitations</b>	<ul style="list-style-type: none"> <li>• Potential leaching of plasticizers</li> <li>• Not recommended for human blood and tissue</li> </ul>															
<b>Physical Properties</b>	<ul style="list-style-type: none"> <li>• Thermoplastic</li> <li>• PVC-based material with plasticizer</li> <li>• Flexible, firm, transparent</li> </ul>															
<b>Service Temperature Range</b>	-50 °C to +74 °C (-58 °F to +165 °F)															
<b>Applications</b>	<table border="1"> <tr><td>Acids</td><td>Good</td></tr> <tr><td>Alkaline solutions</td><td>Good</td></tr> <tr><td>Solvents</td><td>Not recommended</td></tr> <tr><td>Pressure</td><td>Good</td></tr> <tr><td>Vacuum</td><td>Good</td></tr> <tr><td>Viscous media</td><td>Excellent</td></tr> <tr><td>Sterile media</td><td>Limited</td></tr> </table>		Acids	Good	Alkaline solutions	Good	Solvents	Not recommended	Pressure	Good	Vacuum	Good	Viscous media	Excellent	Sterile media	Limited
Acids	Good															
Alkaline solutions	Good															
Solvents	Not recommended															
Pressure	Good															
Vacuum	Good															
Viscous media	Excellent															
Sterile media	Limited															
<b>Complies with the Following Standards</b>	FDA 21 CFR 175.300; US Pharmacopoeia Class VI															
<b>Sterilization</b>	Autoclavable with steam, 30 minutes at 1 bar (15 psi) and 121 °C (250 °F); tubing will appear milky. Gas sterilization with Ethylene oxide. <b>Not recommended for sterilization with radiation.</b>															
<b>Permeability</b>	<table border="1"> <tr> <td></td> <td>CO<sub>2</sub></td> <td>563</td> <td rowspan="3"> <math display="block">\frac{\text{Volume of gas [cm}^3\text{]} \times \text{wall thickness [mm]}}{\text{Area of tubing ID [cm}^2\text{]} \times \text{time [sec]} \times \text{pressure drop across tubing wall [cm Hg]}} \times 10^{10}</math> </td> </tr> <tr> <td></td> <td>O<sub>2</sub></td> <td>124</td> </tr> <tr> <td></td> <td>N<sub>2</sub></td> <td>67</td> </tr> </table>			CO <sub>2</sub>	563	$\frac{\text{Volume of gas [cm}^3\text{]} \times \text{wall thickness [mm]}}{\text{Area of tubing ID [cm}^2\text{]} \times \text{time [sec]} \times \text{pressure drop across tubing wall [cm Hg]}} \times 10^{10}$		O <sub>2</sub>	124		N <sub>2</sub>	67				
	CO <sub>2</sub>	563	$\frac{\text{Volume of gas [cm}^3\text{]} \times \text{wall thickness [mm]}}{\text{Area of tubing ID [cm}^2\text{]} \times \text{time [sec]} \times \text{pressure drop across tubing wall [cm Hg]}} \times 10^{10}$													
	O <sub>2</sub>	124														
	N <sub>2</sub>	67														
<b>Odor and taste</b>	None															
<b>Toxicity</b>	Non-toxic															
<b>Tubing</b>	<table border="1"> <tr><td>at 0 bar life</td><td>800 hrs</td></tr> <tr><td>at 0.7 bar</td><td>700 hrs</td></tr> </table>		at 0 bar life	800 hrs	at 0.7 bar	700 hrs										
at 0 bar life	800 hrs															
at 0.7 bar	700 hrs															

## Note

Maximum recommended operating pressure can be found on page 199.

Part No.	ID	OD	Length	Price	
<b>STANDARD TUBING</b>					
<b>Tygon LFL Tubing, 1/16" (1.6 mm) WT</b>					
SC0389	1/16" (1.6 mm)	3/16" (4.8 mm)	24.6' (7.5 m)	\$ 203.39	
SC0390	1/8" (3.2 mm)	1/4" (6.4 mm)	24.6' (7.5 m)	107.10	
SC0391	3/16" (4.8 mm)	5/16" (8 mm)	24.6' (7.5 m)	99.86	
SC0392A	1/4" (6.4 mm)	3/8" (9.6 mm)	24.6' (7.5 m)	108.94	
SC0394A	5/16" (8 mm)	7/16" (11.2 mm)	24.6' (7.5 m)	128.01	
<b>Tygon LFL Tubing, 5/8" (3.2 mm) WT</b>					
SC0393	1/4" (6.4 mm)	1/2" (12.8 mm)	24.6' (7.5 m)	\$ 195.23	
SC0395	3/8" (9.5 mm)	5/8" (15.9 mm)	24.6' (7.5 m)	256.02	
SC0396	1/2" (12.7 mm)	5/8" (19.1 mm)	24.6' (7.5 m)	302.33	
<b>STOPPER TUBING</b>					
Part No.	ID	OD	Color	Length	Price
<b>Tygon LFL 2-Stop Tubing for CA Cassettes, 0.91 mm WT (12-pk)</b>					
SC0414	0.01" (0.27 mm)	0.082" (2.09 mm)	orange-blue	15.75" (400 mm)	\$ 59.06
SC0415	0.014" (0.38 mm)	0.086" (2.2 mm)	orange-green	15.75" (400 mm)	59.06
SC0416	0.018" (0.48 mm)	0.09" (2.3 mm)	orange-yellow	15.75" (400 mm)	59.06
SC0417	0.025" (0.64 mm)	0.097" (2.46 mm)	orange-white	15.75" (400 mm)	59.06
<b>Tygon LFL 2-Stop Tubing for CA Cassettes, 0.84 mm WT (12-pk)</b>					
SC0418	0.029" (0.76 mm)	0.096" (2.44 mm)	black-black	15.75" (400 mm)	\$ 59.06
SC0419	0.035" (0.89 mm)	0.101" (2.57 mm)	orange-orange	15.75" (400 mm)	59.06
SC0420	0.04" (1.02 mm)	0.106" (2.7 mm)	white-white	15.75" (400 mm)	59.06
SC0421	0.044" (1.14 mm)	0.111" (2.82 mm)	red-red	15.75" (400 mm)	59.06
SC0422	0.049" (1.25 mm)	0.115" (2.93 mm)	grey-grey	15.75" (400 mm)	59.06
SC0423	0.053" (1.37 mm)	0.120" (3.05 mm)	yellow-yellow	15.75" (400 mm)	59.06
SC0424	0.059" (1.52 mm)	0.127" (3.24 mm)	yellow-blue	15.75" (400 mm)	59.06
SC0425	0.062" (1.6 mm)	0.129" (3.28 mm)	blue-blue	15.75" (400 mm)	59.06
SC0426	0.072" (1.85 mm)	0.139" (3.53 mm)	green-green	15.75" (400 mm)	59.06
SC0427	0.081" (2.06 mm)	0.147" (3.74 mm)	purple-purple	15.75" (400 mm)	59.06
SC0428	0.086" (2.2 mm)	0.152" (3.88 mm)	purple-black	15.75" (400 mm)	59.06
SC0429	0.103" (2.62 mm)	0.169" (4.3 mm)	purple-orange	15.75" (400 mm)	59.06
SC0430	0.109" (2.79 mm)	0.176" (4.47 mm)	purple-white	15.75" (400 mm)	59.06
<b>Tygon LFL 3-Stop Tubing for MS/CA Cassettes, 0.91 mm WT (12-pk)</b>					
SC0397	0.01" (0.27 mm)	0.082" (2.09 mm)	orange-blue	15.75" (400 mm)	\$ 70.79
SC0398	0.014" (0.38 mm)	0.086" (2.2 mm)	orange-green	15.75" (400 mm)	70.79
SC0399A	0.019" (0.48 mm)	0.09" (2.3 mm)	orange-yellow	15.75" (400 mm)	70.79
SC0400	0.025" (0.64 mm)	0.097" (2.46 mm)	orange-white	15.75" (400 mm)	70.79
<b>Tygon LFL 3-Stop Tubing for MS/CA Cassettes, 0.84 mm WT (12-pk)</b>					
SC0401	0.029" (0.76 mm)	0.096" (2.44 mm)	black-black	15.75" (400 mm)	\$ 70.79
SC0402	0.035" (0.89 mm)	0.101" (2.57 mm)	orange-orange	15.75" (400 mm)	70.79
SC0403	0.04" (1.02 mm)	0.106" (2.7 mm)	white-white	15.75" (400 mm)	70.79
SC0404	0.044" (1.14 mm)	0.111" (2.82 mm)	red-red	15.75" (400 mm)	70.79
SC0405	0.049" (1.25 mm)	0.115" (2.93 mm)	grey-grey	15.75" (400 mm)	70.79
SC0406	0.053" (1.37 mm)	0.12" (3.05 mm)	yellow-yellow	15.75" (400 mm)	70.79
SC0407	0.059" (1.52 mm)	0.127" (3.24 mm)	yellow-blue	15.75" (400 mm)	70.79
SC0408	0.062" (1.6 mm)	0.129" (3.28 mm)	blue-blue	15.75" (400 mm)	70.79
SC0409A	0.072" (1.85 mm)	0.139" (3.53 mm)	green-green	15.75" (400 mm)	70.79
SC0410	0.081" (2.06 mm)	0.147" (3.74 mm)	purple-purple	15.75" (400 mm)	70.79
SC0411	0.086" (2.2 mm)	0.152" (3.88 mm)	purple-black	15.75" (400 mm)	70.79
SC0412A	0.103" (2.62 mm)	0.169" (4.3 mm)	purple-orange	15.75" (400 mm)	70.79
SC0413	0.109" (2.79 mm)	0.176" (4.47 mm)	purple-white	15.75" (400 mm)	70.79

## Tygon® 2001 Tubing for Aggressive Media

- ▶ High chemical resistance for broad application use
- ▶ Options available for single and multi-channel pump systems
- ▶ Ultra-pure tubing for peristaltic pumps

Tygon 2001 tubing features all of the benefits of most Tygon blends – including wall transparency and FDA approval. Added to this is strong chemical resistance for many solutions (excluding hydrocarbons), making Tygon 2001 a material of choice for many demanding applications where other blends may not be suitable.

Options are available in both Standard Tubing, up to 0.626" (15.9 mm) and Stopper Tubing up to 0.109" (2.79 mm).



### Note

Maximum recommended operating pressure can be found on page 199.

### Specifications

<b>Special Properties</b>	The transparent, plasticiser-free tubing with superior pump-life. Especially designed for MEK and other aggressive solvents.	
<b>Advantages</b>	<ul style="list-style-type: none"> <li>• Plasticizer and oil-free</li> <li>• Smooth inner-bore</li> <li>• Low sorption maintains fluid and tube integrity</li> <li>• Does not impart anything into the pumping medium</li> <li>• No release of hazardous materials when properly incinerated</li> </ul>	
<b>Limitations</b>	None	
<b>Physical Properties</b>	Polyolefin	
<b>Service Temperature Range</b>	-73 °C to +57 °C (-100 °F to +135 °F)	
<b>Applications</b>	Acids	Excellent
	Alkaline solutions	Excellent
	Solvents	Good / Excellent
<b>Complies with the Following Standards</b>	FDA certification for food contact	
<b>Sterilization</b>	Autoclaveable with steam, 30 minutes at 1 bar (15 psi) and 141 °C (250 °F). Gas sterilization with Ethylene oxide. Sterilization with radiation up to 2.5 mrad.	
<b>Permeability</b>	CO <sub>2</sub> 1140	$\frac{\text{Volume of gas [cm}^3\text{] x wall thickness [mm]}}{\text{Area of tubing ID [cm}^2\text{] x time [sec] x pressure drop across tubing wall [cm Hg]}} \times 10^{-10}$
	O <sub>2</sub> 76	
	N <sub>2</sub> 190	
<b>Odor and taste</b>	No odor or taste	
<b>Toxicity</b>	-	
<b>Tubing</b>	at 0 bar life	75 hrs
	at 0.7 bar	-

### Application Note

Smooth inner surface, low sorption maintains fluid and tube integrity.

- ▶ Transparent for visible flow monitoring
- ▶ Coating of tablets
- ▶ Laboratory analysis and dispensing
- ▶ Chemical-based flow in waste water treatment

Part No.	ID	OD	Length	Price		
<b>STANDARD TUBING</b>						
<b>Tygon 2001 Tubing, 1.6 mm WT</b>						
SC0830	0.062" (1.6 mm)	0.189" (4.8 mm)	49.2' (15 m)	\$ 91.70		
SC0831	0.126" (3.2 mm)	0.252" (6.4 mm)	49.2' (15 m)	106.18		
SC0832	0.189" (4.8 mm)	0.315" (8 mm)	49.2' (15 m)	138.01		
SC0833	0.252" (6.4 mm)	0.378" (9.6 mm)	49.2' (15 m)	260.51		
SC0834	0.315" (8 mm)	0.441" (11.2 mm)	49.2' (15 m)	286.82		
SC0835	0.374" (9.5 mm)	0.50" (12.7 mm)	49.2' (15 m)	314.98		
<b>Tygon 2001 Tubing, 3.2 mm WT</b>						
SC0845	0.50" (12.7 mm)	0.752" (19.1 mm)	49.2' (15 m)	\$ 442.07		
SC0846	0.626" (15.9 mm)	0.878" (22.3 mm)	49.2' (15 m)	1,115.68		
<b>STOPPER TUBING</b>						
Part No.	ID	OD	Color	Length	Qty.	Price
<b>Tygon 2001 2-Stop Tubing for CA Cassettes, 0.9 mm WT</b>						
SC0814	0.014" (0.38 mm)	0.085" (2.18 mm)	orange-green	15" (381 mm)	6-pk	\$ 63.55
SC0816	0.025" (0.64 mm)	0.096" (2.44 mm)	orange-white	15" (381 mm)	6-pk	63.55
<b>Tygon 2001 2-Stop Tubing for CA Cassettes, 0.85 mm WT</b>						
SC0818	0.04" (1.02 mm)	0.107" (2.72 mm)	white-white	15" (381 mm)	6-pk	\$ 63.55
SC0820	0.059" (1.52 mm)	0.127" (3.22 mm)	yellow-blue	15" (381 mm)	6-pk	63.55
SC0822	0.081" (2.06 mm)	0.148" (3.76 mm)	purple-purple	15" (381 mm)	6-pk	63.55
SC0824	0.109" (2.79 mm)	0.177" (4.49 mm)	purple-white	15" (381 mm)	6-pk	63.55
<b>Tygon 2001 2-Stop Tubing for MS/CA Cassettes, 0.9 mm WT</b>						
SC0802	0.015" (0.38 mm)	0.085" (2.18 mm)	orange-green	15" (381 mm)	6-pk	\$ 54.47
SC0804	0.025" (0.64 mm)	0.096" (2.44 mm)	orange-white	15" (381 mm)	6-pk	54.47
<b>Tygon 2001 2-Stop Tubing for MS/CA Cassettes, 0.85 mm WT</b>						
SC0806	0.04" (1.02 mm)	0.107" (2.72 mm)	white-white	15" (381 mm)	6-pk	\$ 54.47
SC0808	0.059" (1.52 mm)	0.127" (3.22 mm)	yellow-blue	15" (381 mm)	6-pk	54.47
SC0810	0.081" (2.06 mm)	0.148" (3.76 mm)	purple-purple	15" (381 mm)	6-pk	54.47
SC0812A	0.109" (2.79 mm)	0.177" (4.49 mm)	purple-white	15" (381 mm)	6-pk	54.47

## Tygon® MHLL Tubing

- ▶ Dual-layered tubing material
- ▶ Pairs chemical resistance and long-life

Tygon MHLL is a unique tubing material, comprised of an inner layer of Tygon MH and an outer layer of PharMed®. This combination helps ensure excellent chemical resistance (except for hydrocarbons and strong ketones) as well as long service life. Available as Stopper Tubing for use with MS/CA cassettes.

Additionally, this material offers both FDA approval as well as USP Class VI approval, making it a material of choice for more demanding life-science applications.



## Specifications

<b>Special Properties</b>	<ul style="list-style-type: none"> <li>• The tubing can be used with acetone and MEK</li> <li>• Long life tubing</li> </ul>
<b>Advantages</b>	<ul style="list-style-type: none"> <li>• Plasticiser-free</li> <li>• Smooth inner-bore</li> <li>• Low sorption maintains fluid integrity</li> <li>• Minimal adhesion and diffusion</li> <li>• Suitable for MEK, Acetone and other corrosive solvents</li> <li>• Long life tubing</li> </ul>
<b>Limitations</b>	<ul style="list-style-type: none"> <li>• Cannot be repeatedly sterilized</li> <li>• Only available as stopper tubing</li> </ul>
<b>Physical Properties</b>	<ul style="list-style-type: none"> <li>• Special thermoplastic of high purity</li> <li>• Without additives</li> <li>• Without plasticizer</li> <li>• Environmental-friendly disposal</li> <li>• Flexible, firm, opaque</li> </ul>
<b>Service Temperature Range</b>	-70 °C to +74 °C (-94 °F to + 165 °F)
<b>Applications</b>	
Acids	Excellent
Alkaline solutions	Excellent
Solvents	Excellent
Pressure	Not recommended
Vacuum	Good
Viscous media	Good
Sterile media	Good
<b>Complies with the Following Standards</b>	FDA 21 CFR, Part 177.2600; USP Pharmacopoea Class VI FDA certification for food contact
<b>Sterilization</b>	Autoclaveable with steam, 30 minutes at 1 bar (15 psi) and 121 °C (250 °F). Gas sterilization with Ethylene oxide. Sterilization with radiation up to 2.5 mrad <b>Caution: Can not be repeatedly sterilized.</b>
<b>Permeability</b>	
CO <sub>2</sub>	—
O <sub>2</sub>	—
N <sub>2</sub>	—
<b>Odor and taste</b>	No odor or taste
<b>Toxicity</b>	—
<b>Tubing</b>	at 0 bar life 800+ hrs at 0.7 bar 800+ hrs

## Application Note

Its exceptionally smooth inner surface inhibits particulate buildup and reduces the potential for contamination.

- ▶ Battery acid filling
- ▶ Addition of anti-foam
- ▶ Hazardous material handling
- ▶ Applications with acids, bases, ketones, salts and alcohols

## Note

Maximum recommended operating pressure can be found on page 199.

Part No.	ID	OD	Color	Length	Qty.	Price
<b>TYGON MHLL 2-STOP TUBING FOR CA CASSETTES, 0.92 mm WT</b>						
SC0716	0.015" (0.38 mm)	0.087" (2.22 mm)	orange-green	15" (381 mm)	6-pk	\$ 81.70
SC0717	0.029" (0.76 mm)	0.102" (2.6 mm)	black-black	15" (381 mm)	6-pk	81.70
SC0718	0.045" (1.14 mm)	0.117" (2.98 mm)	red-red	15" (381 mm)	6-pk	81.70
SC0719	0.06" (1.52 mm)	0.132" (3.36 mm)	yellow-blue	15" (381 mm)	6-pk	81.70
SC0720	0.081" (2.06 mm)	0.153" (3.9 mm)	purple-purple	15" (381 mm)	6-pk	81.70
SC0721	0.11" (2.79 mm)	0.182" (4.63 mm)	purple-white	15" (381 mm)	6-pk	81.70
<b>TYGON MHLL 2-STOP TUBING FOR MS/CA CASSETTES, 0.92 mm WT</b>						
SC0710	0.015" (0.38 mm)	0.087" (2.22 mm)	orange-green	11.8" (300 mm)	6-pk	\$ 72.62
SC0711	0.029" (0.76 mm)	0.102" (2.6 mm)	black-black	11.8" (300 mm)	6-pk	72.62
SC0712	0.045" (1.14 mm)	0.117" (2.98 mm)	red-red	11.8" (300 mm)	6-pk	72.62
SC0713	0.06" (1.52 mm)	0.132" (3.36 mm)	yellow-blue	11.8" (300 mm)	6-pk	72.62
SC0714	0.081" (2.06 mm)	0.153" (3.9 mm)	purple-purple	11.8" (300 mm)	6-pk	72.62
SC0715	0.11" (2.79 mm)	0.182" (4.63 mm)	purple-white	11.8" (300 mm)	6-pk	72.62

## Tygon® F-4040-A Tubing

- ▶ Specially formulated for hydrocarbon-based applications
- ▶ Features low gas permeability and good pressure resistance

Tygon F-4040-A tubing has been specially-formulated for use in petroleum (and similar) applications where other Tygon blends cannot be used successfully. The material offers some of the lowest gas permeability rates for atmospheric gases of all the Tygon blends, making it ideal for use in those applications where sensitivity to gas permeation is high or where vacuum may be applied.

In addition to being suitable for hydrocarbon-based applications, this material can also be used successfully with low-concentration acidic solutions as well as mineral salt solutions.

Yellow-tinted, the material offers some degree of translucency, however, it is not as transparent as many other Tygon blends.



### Note

Maximum recommended operating pressure can be found on page 200.

### Specifications

<b>Special Properties</b>	The special tubing for hydrocarbons, petroleum products and distillates.															
<b>Advantages</b>	<ul style="list-style-type: none"> <li>• Specially formulated to transport hydrocarbons, petroleum products and distillates</li> <li>• Ideal for gasoline, kerosene, heating oils, cutting liquids and coolants based on glycols</li> <li>• High dielectric constant</li> <li>• Low gas permeability</li> </ul>															
<b>Limitations</b>	<ul style="list-style-type: none"> <li>• Not recommended for strong acids and alkalis, foodstuffs, beverages and medicines</li> <li>• Potential leaching of plasticizers</li> </ul>															
<b>Physical Properties</b>	<ul style="list-style-type: none"> <li>• Thermoplastic</li> <li>• PVC-based material with plasticizer</li> <li>• Flexible, firm, translucent, yellow</li> </ul>															
<b>Service Temperature Range</b>	-37 °C to +74 °C (-35 °F to +165 °F)															
<b>Applications</b>	<table border="1"> <tr><td>Acids</td><td>Limited</td></tr> <tr><td>Alkaline solutions</td><td>Not recommended</td></tr> <tr><td>Solvents</td><td>Not recommended</td></tr> <tr><td>Pressure</td><td>Good</td></tr> <tr><td>Vacuum</td><td>Good</td></tr> <tr><td>Viscous media</td><td>Excellent</td></tr> <tr><td>Sterile media</td><td>Limited</td></tr> </table>		Acids	Limited	Alkaline solutions	Not recommended	Solvents	Not recommended	Pressure	Good	Vacuum	Good	Viscous media	Excellent	Sterile media	Limited
Acids	Limited															
Alkaline solutions	Not recommended															
Solvents	Not recommended															
Pressure	Good															
Vacuum	Good															
Viscous media	Excellent															
Sterile media	Limited															
<b>Complies with the Following Standards</b>	None															
<b>Sterilization</b>	Not recommended															
<b>Permeability</b>	$\frac{\text{Volume of gas [cm}^3\text{]} \times \text{wall thickness [mm]}}{\text{Area of tubing ID [cm}^2\text{]} \times \text{time [sec]} \times \text{pressure drop across tubing wall [cm Hg]}} \times 10^{-10}$															
	CO <sub>2</sub>	100														
	O <sub>2</sub>	22														
	N <sub>2</sub>	12														
<b>Odor and taste</b>	Must not be used for foodstuffs, beverages and drugs.															
<b>Toxicity</b>	Must not be used for foodstuffs, beverages and drugs.															
<b>Tubing</b>	at 0 bar life	60 hrs														
	at 0.7 bar	60 hrs														

Product ID	OD	Length	Price		
<b>STANDARD TUBING</b>					
<b>Tygon F-4040-A Tubing, 1.6 mm WT</b>					
MF0002	0.063" (1.6 mm) 0.189" (4.8 mm)	49.2' (15 m)	\$ 45.39		
MF0004	0.126" (3.2 mm) 0.252" (6.4 mm)	49.2' (15 m)	59.87		
MF0003	0.189" (4.8 mm) 0.315" (8 mm)	49.2' (15 m)	82.62		
MF0005	0.252" (6.4 mm) 0.378" (9.6 mm)	49.2' (15 m)	100.78		
MF0006	0.315" (8 mm) 0.441" (11.2 mm)	49.2' (15 m)	118.01		
<b>Tygon F-4040-A Tubing, 2.4 mm WT</b>					
MF0476	0.189" (4.8 mm) 0.378" (9.6 mm)	49.2' (15 m)	\$ 142.49		
MF0007	0.252" (6.4 mm) 0.441" (11.2 mm)	49.2' (15 m)	194.31		
<b>Tygon F-4040-A Tubing, 3.2 mm WT</b>					
MF0008	0.374" (9.5 mm) 0.626" (15.9 mm)	49.2' (15 m)	\$ 421.26		
SC0725	0.50" (12.7 mm) 0.752" (19.1 mm)	49.2' (15 m)	507.76		
<b>STOPPER TUBING</b>					
Product ID	OD	Color	Length	Qty.	Price
<b>Tygon F-4040-A 2-Stop Tubing for CA Cassettes, 0.91 mm WT</b>					
SC0156	0.01" (0.25 mm) 0.082" (2.07 mm)	orange-blue	15.75" (400 mm)	12-pk	\$ 32.64
SC0157	0.015" (0.38 mm) 0.086" (2.2 mm)	orange-green	15.75" (400 mm)	12-pk	32.64
SC0158	0.02" (0.51 mm) 0.09" (2.3 mm)	orange-yellow	15.75" (400 mm)	12-pk	32.64
SC0159	0.025" (0.64 mm) 0.097" (2.46 mm)	orange-white	15.75" (400 mm)	12-pk	32.64
<b>Tygon F-4040-A 2-Stop Tubing for CA Cassettes, 0.84 mm WT</b>					
SC0160	0.03" (0.76 mm) 0.096" (2.44 mm)	black-black	15.75" (400 mm)	12-pk	\$ 32.64
SC0161	0.035" (0.89 mm) 0.101" (2.57 mm)	orange-orange	15.75" (400 mm)	12-pk	32.64
SC0162	0.04" (1.02 mm) 0.106" (2.7 mm)	white-white	15.75" (400 mm)	12-pk	32.64
SC0163	0.045" (1.14 mm) 0.111" (2.82 mm)	red-red	15.75" (400 mm)	12-pk	32.64
SC0164	0.051" (1.3 mm) 0.115" (2.93 mm)	grey-grey	15.75" (400 mm)	12-pk	32.64
SC0165	0.056" (1.42 mm) 0.12" (3.05 mm)	yellow-yellow	15.75" (400 mm)	12-pk	32.64
SC0166	0.06" (1.52 mm) 0.127" (3.24 mm)	yellow-blue	15.75" (400 mm)	12-pk	32.64
SC0167	0.065" (1.65 mm) 0.129" (3.28 mm)	blue-blue	15.75" (400 mm)	12-pk	32.64
SC0168	0.073" (1.85 mm) 0.139" (3.53 mm)	green-green	15.75" (400 mm)	12-pk	32.64
SC0169	0.081" (2.06 mm) 0.147" (3.74 mm)	purple-purple	15.75" (400 mm)	12-pk	32.64
SC0170	0.09" (2.29 mm) 0.152" (3.88 mm)	purple-black	15.75" (400 mm)	12-pk	32.64
SC0171	0.10" (2.54 mm) 0.169" (4.3 mm)	purple-orange	15.75" (400 mm)	12-pk	32.64
SC0172	0.11" (2.79 mm) 0.176" (4.47 mm)	purple-white	15.75" (400 mm)	12-pk	32.64
<b>Tygon F-4040-A 3-Stop Tubing for MS/CA Cassettes, 0.91 mm WT</b>					
SC0286	0.01" (0.25 mm) 0.082" (2.07 mm)	orange-blue	15.75" (400 mm)	12-pk	\$ 39.07
SC0287	0.015" (0.38 mm) 0.086" (2.2 mm)	orange-green	15.75" (400 mm)	12-pk	39.07
SC0288A	0.02" (0.51 mm) 0.09" (2.3 mm)	orange-yellow	15.75" (400 mm)	12-pk	39.07
SC0289A	0.025" (0.64 mm) 0.097" (2.46 mm)	orange-white	15.75" (400 mm)	12-pk	39.07
<b>Tygon F-4040-A 3-Stop Tubing for MS/CA Cassettes, 0.84 mm WT</b>					
SC0290A	0.03" (0.76 mm) 0.096" (2.44 mm)	black-black	15.75" (400 mm)	12-pk	\$ 39.07
SC0291	0.035" (0.89 mm) 0.101" (2.57 mm)	orange-orange	15.75" (400 mm)	12-pk	39.07
SC0292	0.04" (1.02 mm) 0.106" (2.7 mm)	white-white	15.75" (400 mm)	12-pk	39.07
SC0293	0.045" (1.14 mm) 0.111" (2.82 mm)	red-red	15.75" (400 mm)	12-pk	39.07
SC0294	0.051" (1.3 mm) 0.115" (2.93 mm)	grey-grey	15.75" (400 mm)	12-pk	39.07
SC0295	0.056" (1.42 mm) 0.12" (3.05 mm)	yellow-yellow	15.75" (400 mm)	12-pk	39.07
SC0296	0.06" (1.52 mm) 0.127" (3.24 mm)	yellow-blue	15.75" (400 mm)	12-pk	39.07
SC0297	0.065" (1.65 mm) 0.129" (3.28 mm)	blue-blue	15.75" (400 mm)	12-pk	39.07
SC0298A	0.073" (1.85 mm) 0.139" (3.53 mm)	green-green	15.75" (400 mm)	12-pk	39.07
SC0299	0.081" (2.06 mm) 0.147" (3.74 mm)	purple-purple	15.75" (400 mm)	12-pk	39.07
SC0300A	0.09" (2.29 mm) 0.152" (3.88 mm)	purple-black	15.75" (400 mm)	12-pk	39.07
SC0301	0.10" (2.54 mm) 0.169" (4.3 mm)	purple-orange	15.75" (400 mm)	12-pk	39.07
SC0302	0.11" (2.79 mm) 0.176" (4.47 mm)	purple-white	15.75" (400 mm)	12-pk	39.07

## Tygon® MH Tubing

- ▶ This tubing is environmentally friendly as it contains no plasticizers or additives; the disposal of the tubing is easily handled
- ▶ Suitable for corrosive solvents yet has an extremely smooth inner surface



### Note

#### How to Make Connections with Tube Sleeves

- ▶ The tubing material of the tube sleeves should be equal to the tubes to be connected.
- ▶ For the tube sleeve choose an inner diameter that equals the outer diameter of the tubes to be connected.
- ▶ If possible, clean the tube bore thoroughly with compressed air.
- ▶ For information on ordering adhesives, please go to [www.idex-hs.com](http://www.idex-hs.com) or contact IDEX Health & Science technical support.

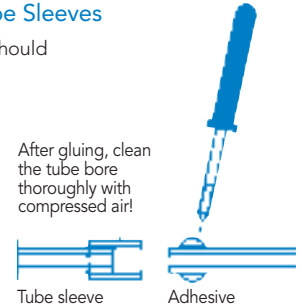

## Specifications

<b>Special Properties</b>	The environmental-friendly tubing especially designed for solvents	
<b>Advantages</b>	<ul style="list-style-type: none"> <li>• Suitable for methyl ethyl ketone (MEK), acetone and other corrosive solvents</li> <li>• Easily disposable</li> </ul>	
<b>Limitations</b>	<ul style="list-style-type: none"> <li>• No additives</li> <li>• No plasticizers</li> </ul>	
<b>Physical Properties</b>	• Extremely smooth inner surface	
<b>Service Temperature Range</b>	-70 °C to +52 °C (-94 °F to +126 °F)	
<b>Applications</b>	Acids	Excellent
	Alkaline solutions	Excellent
	Solvents	Excellent
	Pressure	Not recommended
	Vacuum	Good
	Viscous media	Good
	Sterile media	Good
<b>Complies with the Following Standards</b>	FDA 21 CFR 177.2600; US Pharmacopoeia, Class VI	
<b>Sterilization</b>	Radiation, ethylene oxide and steam	
<b>Permeability</b>	$\frac{\text{Volume of gas [cm}^3\text{]} \times \text{wall thickness [mm]}}{\text{Area of tubing ID [cm}^2\text{]} \times \text{time [sec]} \times \text{pressure drop across tubing wall [cm Hg]}} \times 10^{-10}$	
	CO <sub>2</sub>	4840
	O <sub>2</sub>	980
	N <sub>2</sub>	350
<b>Odor and taste</b>	MH 2075 is FDA approved for food contact	
<b>Toxicity</b>	MH 2075 is FDA approved for food contact	
<b>Tubing</b>	at 0 bar	60 hrs
	at 0.7 bar	60 hrs

Part No.	ID	OD	Length	Price
<b>STANDARD TUBING</b>				
<b>Tygon MH Tubing, 1.6 mm WT</b>				
SC0540	0.063" (1.6 mm)	0.189" (4.8 mm)	49.2' (15 m)	\$ 89.18
SC0541	0.126" (3.2 mm)	0.252" (6.4 mm)	49.2' (15 m)	124.34
SC0542	0.189" (4.8 mm)	0.315" (8 mm)	49.2' (15 m)	136.17
SC0543	0.252" (6.4 mm)	0.378" (9.6 mm)	49.2' (15 m)	151.57
SC0544	0.315" (8 mm)	0.441" (11.2 mm)	49.2' (15 m)	167.08
SC0545A	0.374" (9.5 mm)	0.5" (12.7 mm)	49.2' (15 m)	188.80
<b>Tygon MH Tubing, 3.2 mm WT</b>				
SC0546	0.50" (12.7 mm)	0.752" (19.1 mm)	49.2' (15 m)	\$ 422.99
SC0547	0.626" (15.9 mm)	0.878" (22.3 mm)	49.2' (15 m)	506.53

## Tygon® SI Tubing

- ▶ Platinum-cured silicone tubing
- ▶ Features ultra-smooth inner-bore
- ▶ Biocompatible for life science applications

Tygon SI tubing is a special silicone-based tubing that undergoes a special treatment with platinum to ensure a very smooth internal surface. This surface feature helps improve the material's use with biological applications where solid material may be present. Additionally, the material exhibits a low-level of protein-binding as well as being non-toxic, helping to make this material the top choice for many life science applications.



### Note

Maximum recommended operating pressure can be found on page 200.

### Specifications

#### Tygon SI Silicone 3350 (Platinum) Tubing

<b>Special Properties</b>	The platinum-cured silicone tubing with an ultra-smooth inner surface for sanitary transfer of sensitive fluids.															
<b>Advantages</b>	<ul style="list-style-type: none"> <li>• Steam autoclavability</li> <li>• Excellent biological compatibility</li> <li>• Ultra-smooth inner-bore reduces potential for particle entrapment</li> <li>• Lower level of protein binding</li> <li>• Entirely non-toxic, non-hemolytic and non-pyrogenic</li> <li>• Weather, ozone, sunlight and radiation resistant</li> <li>• Resistant to fungus</li> <li>• Odorless</li> </ul>															
<b>Limitations</b>	<ul style="list-style-type: none"> <li>• Not suitable for concentrated solvents, oils, acids or diluted sodium hydroxide</li> <li>• Relatively high gas permeability</li> </ul>															
<b>Physical Properties</b>	<ul style="list-style-type: none"> <li>• Thermal set rubber</li> <li>• Siloxane polymers and amorphous silica</li> <li>• Soft, translucent, clear to light amber</li> <li>• Excellent compression strength</li> </ul>															
<b>Service Temperature Range</b>	-60 °C to +200 °C (-75 °F to +392 °F)															
<b>Applications</b>	<table border="1"> <tr><td>Acids</td><td>Limited</td></tr> <tr><td>Alkaline solutions</td><td>Limited</td></tr> <tr><td>Solvents</td><td>Limited</td></tr> <tr><td>Pressure</td><td>Not recommended</td></tr> <tr><td>Vacuum</td><td>Good</td></tr> <tr><td>Viscous media</td><td>Fair</td></tr> <tr><td>Sterile media</td><td>Excellent</td></tr> </table>		Acids	Limited	Alkaline solutions	Limited	Solvents	Limited	Pressure	Not recommended	Vacuum	Good	Viscous media	Fair	Sterile media	Excellent
Acids	Limited															
Alkaline solutions	Limited															
Solvents	Limited															
Pressure	Not recommended															
Vacuum	Good															
Viscous media	Fair															
Sterile media	Excellent															
<b>Complies with the Following Standards</b>	US Pharmacopoeia XXIII Cl.VI, FDA 21 CFR, Part 177.2600. Also exceeds 3A sanitary standards.															
<b>Sterilization</b>	Autoclavable with steam, 30 minutes at 1 bar (15 psi) and 121 °C (250 °F) Gas sterilization with Ethylene oxide Sterilization with radiation up to 2.5 mrad.															
<b>Permeability</b>	<table border="1"> <tr> <td>CO<sub>2</sub></td> <td>25147</td> <td rowspan="3"> <math display="block">\frac{\text{Volume of gas [cm}^3\text{]} \times \text{wall thickness [mm]}}{\text{Area of tubing ID [cm}^2\text{]} \times \text{time [sec]} \times \text{pressure drop across tubing wall [cm Hg]}} \times 10^{-10}</math> </td> </tr> <tr> <td>O<sub>2</sub></td> <td>4715</td> </tr> <tr> <td>N<sub>2</sub></td> <td>2284</td> </tr> </table>		CO <sub>2</sub>	25147	$\frac{\text{Volume of gas [cm}^3\text{]} \times \text{wall thickness [mm]}}{\text{Area of tubing ID [cm}^2\text{]} \times \text{time [sec]} \times \text{pressure drop across tubing wall [cm Hg]}} \times 10^{-10}$	O <sub>2</sub>	4715	N <sub>2</sub>	2284							
CO <sub>2</sub>	25147	$\frac{\text{Volume of gas [cm}^3\text{]} \times \text{wall thickness [mm]}}{\text{Area of tubing ID [cm}^2\text{]} \times \text{time [sec]} \times \text{pressure drop across tubing wall [cm Hg]}} \times 10^{-10}$														
O <sub>2</sub>	4715															
N <sub>2</sub>	2284															
<b>Odor and taste</b>	None															
<b>Toxicity</b>	Non-toxic															
<b>Tubing</b>	<table border="1"> <tr><td>at 0 bar life</td><td>200 hrs</td></tr> <tr><td>at 0.7 bar</td><td>100 hrs</td></tr> </table>		at 0 bar life	200 hrs	at 0.7 bar	100 hrs										
at 0 bar life	200 hrs															
at 0.7 bar	100 hrs															

Part No.	ID	OD	Length	Price		
<b>STANDARD TUBING</b>						
<b>Tygon SI Tubing, 1.6 mm WT</b>						
MF0291	0.032" (0.8 mm)	0.158" (4 mm)	49.2' (15 m)	\$ 70.79		
SC0580B	0.063" (1.6 mm)	0.189" (4.8 mm)	49.2' (15 m)	106.80		
SC0590B	0.095" (2.4 mm)	0.221" (5.6 mm)	49.2' (15 m)	132.00		
SC0581B	0.126" (3.2 mm)	0.252" (6.4 mm)	49.2' (15 m)	135.30		
SC0582B	0.189" (4.8 mm)	0.315" (8 mm)	49.2' (15 m)	172.70		
SC0584B	0.252" (6.4 mm)	0.378" (9.6 mm)	49.2' (15 m)	188.70		
SC0587B	0.315" (8 mm)	0.441" (11.2 mm)	49.2' (15 m)	235.00		
SC0387B	0.374" (9.5 mm)	0.5" (12.7 mm)	49.2' (15 m)	146.20		
SC0697B	0.437" (11.1 mm)	0.563" (14.3 mm)	49.2' (15 m)	151.93		
<b>Tygon SI Tubing, 2.4 mm WT</b>						
SC0583B	0.189" (4.8 mm)	0.378" (9.6 mm)	49.2' (15 m)	\$ 246.50		
SC0585B	0.252" (6.4 mm)	0.441" (11.2 mm)	49.2' (15 m)	288.40		
SC0515B	0.315" (8 mm)	0.504" (12.8 mm)	49.2' (15 m)	150.65		
SC0516B	0.374" (9.5 mm)	0.563" (14.3 mm)	49.2' (15 m)	211.99		
SC0517B	0.437" (11.1 mm)	0.626" (15.9 mm)	49.2' (15 m)	441.15		
SC0518B	0.50" (12.7 mm)	0.689" (17.5 mm)	49.2' (15 m)	472.97		
SC0519B	0.626" (15.9 mm)	0.815" (20.7 mm)	49.2' (15 m)	584.66		
<b>Tygon SI Tubing, 3.2 mm WT</b>						
SC0586B	0.025" (0.64 mm)	0.504" (12.8 mm)	49.2' (15 m)	\$ 390.70		
SC0588B	0.374" (9.5 mm)	0.626" (15.9 mm)	49.2' (15 m)	218.00		
SC0589	0.50" (12.7 mm)	0.752" (19.1 mm)	49.2' (15 m)	627.30		
SC0532B	0.626" (15.9 mm)	0.878" (22.3 mm)	49.2' (15 m)	750.72		
<b>Tygon SI Tubing, 6 mm WT</b>						
MF0359	0.374" (9.5 mm)	0.847" (21.5 mm)	49.2' (15 m)	\$ 470.22		
MF0361	0.748" (19 mm)	1.22" (31 mm)	49.2' (15 m)	678.10		
<b>Tygon SI Tubing, 5 mm WT</b>						
MF0360	0.50" (12.7 mm)	0.894" (22.7 mm)	49.2' (15 m)	\$ 436.66		
<b>Tygon SI Tubing, 4 mm WT</b>						
MF0362	1.0" (25.4 mm)	1.315" (33.4 mm)	49.2' (15 m)	\$ 701.76		
<b>STOPPER TUBING</b>						
Part No.	ID	OD	Color	Length	Qty.	Price
<b>Tygon SI 2-Stop Tubing for CA Cassettes, 0.91 mm WT</b>						
SC0620A	0.02" (0.51 mm)	0.09" (2.3 mm)	orange-yellow	15.75" (400 mm)	6-pk	\$ 37.23
SC0621	0.025" (0.64 mm)	0.097" (2.46 mm)	orange-white	15.75" (400 mm)	6-pk	37.23
<b>Tygon SI 2-Stop Tubing for CA Cassettes, 0.84 mm WT</b>						
SC0622	0.03" (0.76 mm)	0.096" (2.44 mm)	black-black	15.75" (400 mm)	6-pk	\$ 37.23
SC0623	0.035" (0.89 mm)	0.101" (2.57 mm)	orange-orange	15.75" (400 mm)	6-pk	37.23
SC0624	0.04" (1.02 mm)	0.106" (2.7 mm)	white-white	15.75" (400 mm)	6-pk	37.23
SC0625A	0.045" (1.14 mm)	0.111" (2.82 mm)	red-red	15.75" (400 mm)	6-pk	37.23
SC0626	0.051" (1.3 mm)	0.115" (2.93 mm)	grey-grey	15.75" (400 mm)	6-pk	37.23
SC0627A	0.056" (1.42 mm)	0.12" (3.05 mm)	yellow-yellow	15.75" (400 mm)	6-pk	37.23
SC0628	0.06" (1.52 mm)	0.127" (3.24 mm)	yellow-blue	15.75" (400 mm)	6-pk	37.23
SC0629A	0.065" (1.65 mm)	0.129" (3.28 mm)	blue-blue	15.75" (400 mm)	6-pk	37.23
SC0630	0.073" (1.85 mm)	0.139" (3.53 mm)	blue-green	15.75" (400 mm)	6-pk	37.23
SC0631	0.081" (2.06 mm)	0.147" (3.74 mm)	purple-purple	15.75" (400 mm)	6-pk	37.23
SC0632	0.09" (2.29 mm)	0.152" (3.88 mm)	purple-black	15.75" (400 mm)	6-pk	37.23
SC0633	0.10" (2.54 mm)	0.169" (4.3 mm)	purple-orange	15.75" (400 mm)	6-pk	37.23
SC0634	0.11 (2.79 mm)	0.176" (4.47 mm)	purple-white	15.75" (400 mm)	6-pk	37.23
<b>Tygon SI 3-Stop Tubing for MS/CA Cassettes, 0.91 mm WT</b>						
SC0600A	0.02" (0.51 mm)	0.09" (2.3 mm)	orange-yellow	15.75" (400 mm)	6-pk	\$ 40.90
SC0601A	0.025" (0.64 mm)	0.097" (2.46 mm)	orange-white	15.75" (400 mm)	6-pk	40.90
<b>Tygon SI 3-Stop Tubing for MS/CA Cassettes, 0.84 mm WT</b>						
SC0602A	0.03" (0.76 mm)	0.096" (2.44 mm)	black-black	15.75" (400 mm)	6-pk	\$ 40.90
SC0603	0.035" (0.89 mm)	0.101" (2.57 mm)	orange-orange	15.75" (400 mm)	6-pk	40.90
SC0604A	0.04" (1.02 mm)	0.106" (2.7 mm)	white-white	15.75" (400 mm)	6-pk	40.90
SC0605	0.045" (1.14 mm)	0.111" (2.82 mm)	red-red	15.75" (400 mm)	6-pk	40.90
SC0606	0.051" (1.3 mm)	0.115" (2.93 mm)	grey-grey	15.75" (400 mm)	6-pk	40.90
SC0607A	0.056" (1.42 mm)	0.12" (3.05 mm)	yellow-yellow	15.75" (400 mm)	6-pk	40.90
SC0608	0.06" (1.52 mm)	0.127" (3.24 mm)	yellow-blue	15.75" (400 mm)	6-pk	40.90
SC0609A	0.065" (1.65 mm)	0.129" (3.28 mm)	blue-blue	15.75" (400 mm)	6-pk	40.90
SC0610	0.073" (1.85 mm)	0.139" (3.53 mm)	blue-green	15.75" (400 mm)	6-pk	40.90
SC0611	0.081" (2.06 mm)	0.147" (3.74 mm)	purple-purple	15.75" (400 mm)	6-pk	40.90
SC0612A	0.09" (2.29 mm)	0.152" (3.88 mm)	purple-black	15.75" (400 mm)	6-pk	40.90
SC0613A	0.10" (2.54 mm)	0.169" (4.3 mm)	purple-orange	15.75" (400 mm)	6-pk	40.90
SC0614	0.11 (2.79 mm)	0.176" (4.47 mm)	purple-white	15.75" (400 mm)	6-pk	40.90

## Norprene® Tubing

- ▶ Long-life tubing with strong chemical resistance
- ▶ Excellent option for industrial applications

Norprene tubing is an excellent alternative to traditional rubber tubing in industrial applications where good chemical resistance is paired with a desire for longer service life.

This tubing material offers additional benefits, including low gas permeability and broad temperature range compatibility. Combined, this material's features help make this tubing the tubing of choice in many applications.



### Note

Maximum recommended operating pressure can be found on page 200.

### Specifications

#### Norprene A-60-G Tubing

<b>Special Properties</b>	The high performance tubing for industrial use.	
<b>Advantages</b>	<ul style="list-style-type: none"> <li>• Offers longest service-life with good flow consistency</li> <li>• Good resistance to acids and alkaline chemicals</li> <li>• Superior weathering</li> <li>• Abrasion resistant</li> <li>• Non-aging and non-oxidizing</li> <li>• Outstanding flexural fatigue resistance</li> <li>• Low gas permeability versus rubber tubing</li> <li>• Ozone (300 pphm) and UV light resistant</li> <li>• Ideal for use in vacuum system</li> </ul>	
<b>Limitations</b>	<ul style="list-style-type: none"> <li>• Potential leaching of blend material</li> </ul>	
<b>Physical Properties</b>	<ul style="list-style-type: none"> <li>• Thermoplastic elastomer based on polypropylene</li> <li>• Excellent tensile strength</li> <li>• Firm, opaque, black</li> </ul>	
<b>Service Temperature Range</b>	-60 °C to +135 °C (-75 °F to +275 °F)	
<b>Applications</b>	Acids	Excellent
	Alkaline solutions	Excellent
	Solvents	Not recommended
	Pressure	Not recommended
	Vacuum	Good
	Viscous media	Excellent
	Sterile media	Not recommended
<b>Complies with the Following Standards</b>	None	
<b>Sterilization</b>	Not recommended	
<b>Permeability</b>	$\frac{\text{Volume of gas [cm}^3\text{]} \times \text{wall thickness [mm]}}{\text{Area of tubing ID [cm}^2\text{]} \times \text{time [sec]} \times \text{pressure drop across tubing wall [cm Hg]}} \times 10^{-10}$	
	CO <sub>2</sub>	1200
	O <sub>2</sub>	200
	N <sub>2</sub>	80
<b>Odor and taste</b>	Must not be used for foodstuffs, beverages and drugs.	
<b>Toxicity</b>	Must not be used for foodstuffs, beverages and drugs.	
<b>Tubing</b>	at 0 bar life	1000+ hrs
	at 0.7 bar	1000 hrs

Part No.	ID	OD	Length	Price
<b>STANDARD TUBING</b>				
<b>Norprene Tubing, 1.6 mm WT</b>				
MF0017	0.032" (0.8 mm)	0.158" (4.0 mm)	49.2' (15 m)	\$ 72.62
SC0357	0.063" (1.6 mm)	0.189" (4.8 mm)	49.2' (15 m)	95.37
SC0358	0.126" (3.2 mm)	0.252" (6.4 mm)	49.2' (15 m)	98.94
SC0359	0.189" (4.8 mm)	0.315" (8.0 mm)	49.2' (15 m)	102.61
SC0360	0.252" (6.4 mm)	0.378" (9.6 mm)	49.2' (15 m)	121.69
SC0361	0.315" (8 mm)	0.441" (11.2 mm)	49.2' (15 m)	185.23
SC0385	0.374" (9.5 mm)	0.50" (12.7 mm)	49.2' (15 m)	104.45
SC0386	0.437" (11.1 mm)	0.563" (14.3 mm)	49.2' (15 m)	167.99
<b>Norprene Tubing, 2.4 mm WT</b>				
SC0362	0.189" (4.8 mm)	0.378" (9.6 mm)	49.2' (15 m)	\$ 102.61
SC0363	0.252" (6.4 mm)	0.441" (11.2 mm)	49.2' (15 m)	124.34
SC0511	0.315" (8 mm)	0.504" (12.8 mm)	49.2' (15 m)	126.17
SC0512	0.374" (9.5 mm)	0.563" (14.3 mm)	49.2' (15 m)	150.65
<b>Norprene Tubing, 3.2 mm WT</b>				
SC0364	0.025" (0.64 mm)	0.504" (12.8 mm)	49.2' (15 m)	\$ 182.48
SC0365	0.374" (9.5 mm)	0.626" (15.9 mm)	49.2' (15 m)	262.34
SC0366	0.50" (12.7 mm)	0.752" (19.1 mm)	49.2' (15 m)	216.37
SC0698	0.626" (15.9 mm)	0.878" (22.3 mm)	49.2' (15 m)	291.22

## PharMed® Ismaprene Tubing

- ▶ Excellent chemical resistance for traditional peristaltic pump tubing
- ▶ Offers FDA and USP Class VI certification

PharMed Ismaprene tubing has long been the tubing of choice for many demanding applications where other polymer blends have been unsuitable for use.



With strong chemical resistance, excellent lifetime, and low gas permeability – coupled with industry-standard certifications – PharMed tubing is offered in options for standard pumps as well as for pumps requiring 2-stop and 3-stop tubing. Special versions are available with welded stops for applications where repeated autoclaving must take place.

### Note

Maximum recommended operating pressure can be found on page 199.

### Specifications

<b>Special Properties</b>	The ideal tubing for pharmaceutical and medical applications, and for foodstuffs.															
<b>Advantages</b>	<ul style="list-style-type: none"> <li>• Recommended for cell cultures and tissue</li> <li>• Ideal for production filtration, fermentation and bioreactor process lines</li> <li>• Very long service-life</li> <li>• Non-toxic and non-hemolytic</li> <li>• Impermeable to normal light and UV-radiation</li> <li>• Appropriate for medical products and foodstuffs</li> <li>• Low particulate spallation</li> <li>• Can be autoclaved repeatedly</li> <li>• Withstands repeated CIP and SIP cleaning and sterilization</li> <li>• Meets USP Class VI, FDA and NSF criteria</li> </ul>															
<b>Limitations</b>	<ul style="list-style-type: none"> <li>• Potential leaching of additives (lubricants)</li> </ul>															
<b>Physical Properties</b>	<ul style="list-style-type: none"> <li>• Thermoplastic elastomer based on polypropylene</li> <li>• Firm, opaque, beige color</li> </ul>															
<b>Service Temperature Range</b>	-60 °C to +135 °C (-75 °F to +275 °F)															
<b>Applications</b>	<table border="1"> <tr><td>Acids</td><td>Good</td></tr> <tr><td>Alkaline solutions</td><td>Good</td></tr> <tr><td>Solvents</td><td>Not recommended</td></tr> <tr><td>Pressure</td><td>Not recommended</td></tr> <tr><td>Vacuum</td><td>Excellent</td></tr> <tr><td>Viscous media</td><td>Good</td></tr> <tr><td>Sterile media</td><td>Excellent</td></tr> </table>		Acids	Good	Alkaline solutions	Good	Solvents	Not recommended	Pressure	Not recommended	Vacuum	Excellent	Viscous media	Good	Sterile media	Excellent
Acids	Good															
Alkaline solutions	Good															
Solvents	Not recommended															
Pressure	Not recommended															
Vacuum	Excellent															
Viscous media	Good															
Sterile media	Excellent															
<b>Complies with the Following Standards</b>	FDA 21 CFR Part 177.2600; US Pharmacopoeia Class VI, NSF listed (Standard 51)															
<b>Sterilization</b>	Autoclaveable with steam, 30 minutes at 1 bar (15 psi) and 141 °C (250 °F) Gas sterilization with Ethylene oxide. Sterilization with radiation up to 2.5 mrad. <b>Caution: Use special tubing version (welded stoppers) when autoclaving 2 or 3-stop color-coded tubing.</b>															
<b>Permeability</b>	<table border="1"> <tr> <td></td> <td>CO<sub>2</sub></td> <td>1200</td> <td rowspan="3"> <math display="block">\frac{\text{Volume of gas [cm}^3\text{]} \times \text{wall thickness [mm]}}{\text{Area of tubing ID [cm}^2\text{]} \times \text{time [sec]} \times \text{pressure drop across tubing wall [cm Hg]}} \times 10^{-10}</math> </td> </tr> <tr> <td></td> <td>O<sub>2</sub></td> <td>200</td> </tr> <tr> <td></td> <td>N<sub>2</sub></td> <td>80</td> </tr> </table>			CO <sub>2</sub>	1200	$\frac{\text{Volume of gas [cm}^3\text{]} \times \text{wall thickness [mm]}}{\text{Area of tubing ID [cm}^2\text{]} \times \text{time [sec]} \times \text{pressure drop across tubing wall [cm Hg]}} \times 10^{-10}$		O <sub>2</sub>	200		N <sub>2</sub>	80				
	CO <sub>2</sub>	1200	$\frac{\text{Volume of gas [cm}^3\text{]} \times \text{wall thickness [mm]}}{\text{Area of tubing ID [cm}^2\text{]} \times \text{time [sec]} \times \text{pressure drop across tubing wall [cm Hg]}} \times 10^{-10}$													
	O <sub>2</sub>	200														
	N <sub>2</sub>	80														
<b>Odor and taste</b>	Low															
<b>Toxicity</b>	Non-toxic and non-hemolytic															
<b>Tubing</b>	at 0 bar life	1000+ hrs														
	at 0.7 bar	1000 hrs														

Part No.	ID	OD	Length	Price		
<b>STANDARD TUBING</b>						
<b>PharMed Tubing, 1.6 mm WT</b>						
MF0009A	0.032" (0.8 mm)	0.158" (4.0 mm)	0.295" (7.5 mm)	\$ 88.94		
MF0010A	0.063" (1.6 mm)	0.189" (4.8 mm)	0.295" (7.5 mm)	115.26		
SC1006	0.095" (2.4 mm)	0.221" (5.6 mm)	0.295" (7.5 mm)	150.96		
MF0012	0.126" (3.2 mm)	0.252" (6.4 mm)	0.295" (7.5 mm)	115.26		
MF0011	0.189" (4.8 mm)	0.315" (8.0 mm)	0.295" (7.5 mm)	117.10		
MF0013	0.252" (6.4 mm)	0.378" (9.6 mm)	0.295" (7.5 mm)	138.01		
MF0014	0.315" (8.0 mm)	0.441" (11.2 mm)	0.295" (7.5 mm)	144.33		
<b>PharMed Tubing, 2.4 mm WT</b>						
MF0448	0.189" (4.8 mm)	0.378" (9.6 mm)	0.295" (7.5 mm)	\$ 159.79		
<b>PharMed Tubing, 3.2 mm WT</b>						
MF0015A	0.252" (6.4 mm)	0.504" (12.8 mm)	0.295" (7.5 mm)	\$ 243.27		
MF0016	0.374" (9.5 mm)	0.626" (15.9 mm)	0.295" (7.5 mm)	229.70		
MF0034A	0.50" (12.7 mm)	0.752" (19.1 mm)	0.295" (7.5 mm)	283.35		
SC0696A	0.626" (15.9 mm)	0.878" (22.3 mm)	0.295" (7.5 mm)	295.32		
<b>PharMed Tubing, 6 mm WT</b>						
MF0353	0.748" (19 mm)	1.22" (31 mm)	0.295" (7.5 mm)	\$ 882.40		
<b>PharMed Tubing, 4 mm WT</b>						
MF0354	1.0" (25.4 mm)	1.315" (33.4 mm)	0.295" (7.5 mm)	\$ 955.94		
<b>STOPPER TUBING</b>						
Part No.	ID	OD	Color	Length	Qty.	Price
<b>PharMed 2-STOP Tubing for CA Cassettes, 0.75 mm WT</b>						
SC0328	0.051" (1.3 mm)	0.504" (12.8 mm)	grey-grey	15.75" (400 mm)	6-pk	\$ 36.31
SC0330	0.06" (1.52 mm)	0.119" (3.02 mm)	yellow-blue	15.75" (400 mm)	6-pk	36.31
<b>PharMed 2-Stop Tubing for CA Cassettes, 0.80 mm WT</b>						
SC0324	0.03" (0.76 mm)	0.092" (2.36 mm)	black-black	15.75" (400 mm)	6-pk	\$ 42.64
SC0325	0.035" (0.89 mm)	0.098" (2.49 mm)	orange-orange	15.75" (400 mm)	6-pk	42.64
SC0331	0.065" (1.65 mm)	0.128" (3.25 mm)	blue-blue	15.75" (400 mm)	6-pk	36.31
SC0333	0.081" (2.06 mm)	0.144" (3.66 mm)	purple-purple	15.75" (400 mm)	6-pk	36.31
SC0334	0.09" (2.29 mm)	0.153" (3.89 mm)	purple-black	15.75" (400 mm)	6-pk	36.31
<b>PharMed 2-Stop Tubing for CA Cassettes, 0.84 mm WT</b>						
SC0329	0.056" (1.42 mm)	0.122" (3.1 mm)	yellow-yellow	15.75" (400 mm)	6-pk	\$ 36.31
<b>PharMed 2-Stop Tubing for CA Cassettes, 0.85 mm WT</b>						
SC0322	0.02" (0.51 mm)	0.087" (2.21 mm)	orange-yellow	15.75" (400 mm)	6-pk	\$ 42.64
SC0326	0.04" (1.02 mm)	0.107" (2.72 mm)	white-white	15.75" (400 mm)	6-pk	42.64
SC0327	0.045" (1.14 mm)	0.112" (2.84 mm)	red-red	15.75" (400 mm)	6-pk	36.31
SC0332	0.073" (1.85 mm)	0.14" (3.55 mm)	green-green	15.75" (400 mm)	6-pk	36.31
SC0335	0.10" (2.54 mm)	0.167" (4.24 mm)	purple-orange	15.75" (400 mm)	6-pk	36.31
<b>PharMed 2-Stop Tubing for CA Cassettes, 0.90 mm WT</b>						
SC0321	0.015" (0.38 mm)	0.086" (2.18 mm)	orange-green	15.75" (400 mm)	6-pk	\$ 36.31
SC0323	0.025" (0.64 mm)	0.096" (2.44 mm)	orange-white	15.75" (400 mm)	6-pk	36.31
SC0336	0.11" (2.79 mm)	0.181" (4.59 mm)	purple-white	15.75" (400 mm)	6-pk	42.64
<b>PharMed 2-Stop Tubing for CA Cassettes, 0.91 mm WT</b>						
SC0320	0.01" (0.25 mm)	0.082" (2.07 mm)	orange-blue	15.75" (400 mm)	6-pk	\$ 42.64
<b>PharMed 3-Stop Tubing for MS/CA Cassettes, 0.75 mm WT</b>						
SC0311	0.051" (1.3 mm)	0.11" (2.79 mm)	grey-grey	15.75" (400 mm)	6-pk	\$ 42.64
SC0313	0.06" (1.52 mm)	0.119" (3.02 mm)	yellow-blue	15.75" (400 mm)	6-pk	42.64
<b>PharMed 3-Stop Tubing for MS/CA Cassettes, 0.80 mm WT</b>						
SC0307	0.03" (0.76 mm)	0.092" (2.36 mm)	black-black	15.75" (400 mm)	6-pk	\$ 42.64
SC0308	0.035" (0.89 mm)	0.098" (2.49 mm)	orange-orange	15.75" (400 mm)	6-pk	42.64
SC0314	0.065" (1.65 mm)	0.128" (3.25 mm)	blue-blue	15.75" (400 mm)	6-pk	42.64
SC0316	0.081" (2.06 mm)	0.144" (3.66 mm)	purple-purple	15.75" (400 mm)	6-pk	42.64
SC0317	0.09" (2.29 mm)	0.153" (3.89 mm)	purple-black	15.75" (400 mm)	6-pk	42.64
<b>PharMed 3-Stop Tubing for MS/CA Cassettes, 0.84 mm WT</b>						
SC0312	0.056" (1.42 mm)	0.122" (3.1 mm)	yellow-yellow	15.75" (400 mm)	6-pk	\$ 42.64
<b>PharMed 3-Stop Tubing for MS/CA Cassettes, 0.85 mm WT</b>						
SC0305	0.02" (0.51 mm)	0.087" (2.21 mm)	orange-yellow	15.75" (400 mm)	6-pk	\$ 42.64
SC0309	0.04" (1.02 mm)	0.107" (2.72 mm)	white-white	15.75" (400 mm)	6-pk	42.64
SC0310	0.045" (1.14 mm)	0.112" (2.84 mm)	red-red	15.75" (400 mm)	6-pk	42.64
SC0315	0.073" (1.85 mm)	0.14" (3.55 mm)	green-green	15.75" (400 mm)	6-pk	42.64
SC0318	0.10" (2.54 mm)	0.167" (4.24 mm)	purple-orange	15.75" (400 mm)	6-pk	42.64
<b>PharMed 3-Stop Tubing for MS/CA Cassettes, 0.90 mm WT</b>						
SC0304	0.015" (0.38 mm)	0.086" (2.18 mm)	orange-green	15.75" (400 mm)	6-pk	\$ 42.64
SC0306	0.025" (0.64 mm)	0.096" (2.44 mm)	orange-white	15.75" (400 mm)	6-pk	42.64
SC0319	0.11" (2.79 mm)	0.181" (4.59 mm)	purple-white	15.75" (400 mm)	6-pk	42.64
<b>PharMed 3-Stop Tubing for MS/CA Cassettes, 0.91 mm WT</b>						
SC0303	0.01" (0.25 mm)	0.082" (2.07 mm)	orange-blue	15.75" (400 mm)	6-pk	\$ 42.64

## Silicone Peroxide Tubing

- ▶ Non-toxic material great for biological applications
- ▶ Soft and translucent for applications requiring visual checks



## Specifications

<b>Special Properties</b>	Silicone tubing blended with organic peroxide for biological applications															
<b>Advantages</b>	<ul style="list-style-type: none"> <li>• Steam autoclavability</li> <li>• Excellent biological compatibility</li> <li>• Greater physical compression capability</li> <li>• Not prone to mold</li> <li>• Non-toxic</li> <li>• Waterproof and resistant to ozone, radiation and sunlight</li> <li>• Resistant to fungus</li> <li>• Odorless</li> </ul>															
<b>Limitations</b>	<ul style="list-style-type: none"> <li>• Not recommended for concentrated solvents, oils, acids or diluted sodium hydroxide</li> <li>• Relatively high gas permeability</li> </ul>															
<b>Physical Properties</b>	<ul style="list-style-type: none"> <li>• Polydimethylsiloxane with silica filter and silicone oil</li> <li>• Excellent resistance to compression</li> <li>• Soft, translucent, clear to light amber</li> </ul>															
<b>Service Temperature Range</b>	-51 °C to +238 °C (-60 °F to +460 °F)															
<b>Applications</b>	<table border="1"> <tr><td>Acids</td><td>Limited</td></tr> <tr><td>Alkaline solutions</td><td>Good</td></tr> <tr><td>Solvents</td><td>Not recommended</td></tr> <tr><td>Pressure</td><td>Not recommended</td></tr> <tr><td>Vacuum</td><td>Good</td></tr> <tr><td>Viscous media</td><td>Fair</td></tr> <tr><td>Sterile media</td><td>Excellent</td></tr> </table>		Acids	Limited	Alkaline solutions	Good	Solvents	Not recommended	Pressure	Not recommended	Vacuum	Good	Viscous media	Fair	Sterile media	Excellent
Acids	Limited															
Alkaline solutions	Good															
Solvents	Not recommended															
Pressure	Not recommended															
Vacuum	Good															
Viscous media	Fair															
Sterile media	Excellent															
<b>Complies with the Following Standards</b>	FDA 21 CFR 177.2600; US Pharmacopoeia XXIII Cl.VI															
<b>Sterilization</b>	Autoclavable with steam, 30 minutes at 1 bar (15 psi) and 121 °C (250 °C) Radiation: Irradiate at up to 2.5 mrad <b>Gas: Not recommended to sterilize with ethylene oxide</b>															
<b>Permeability</b>	<table border="1"> <tr> <td></td> <td></td> <td>Volume of gas [cm<sup>3</sup>] x wall thickness {mm}</td> <td rowspan="3">x 10<sup>-10</sup></td> </tr> <tr> <td>CO<sub>2</sub></td> <td>25147</td> <td rowspan="3">Area of tubing ID [cm<sup>2</sup>] x time [sec] x pressure drop across tubing wall [cm Hg]</td> </tr> <tr> <td>O<sub>2</sub></td> <td>4715</td> </tr> <tr> <td>N<sub>2</sub></td> <td>2284</td> </tr> </table>				Volume of gas [cm <sup>3</sup> ] x wall thickness {mm}	x 10 <sup>-10</sup>	CO <sub>2</sub>	25147	Area of tubing ID [cm <sup>2</sup> ] x time [sec] x pressure drop across tubing wall [cm Hg]	O <sub>2</sub>	4715	N <sub>2</sub>	2284			
		Volume of gas [cm <sup>3</sup> ] x wall thickness {mm}	x 10 <sup>-10</sup>													
CO <sub>2</sub>	25147	Area of tubing ID [cm <sup>2</sup> ] x time [sec] x pressure drop across tubing wall [cm Hg]														
O <sub>2</sub>	4715															
N <sub>2</sub>	2284															
<b>Odor and taste</b>	—															
<b>Toxicity</b>	—															
<b>Tubing</b>	<table border="1"> <tr><td>at 0 bar life</td><td>—</td></tr> <tr><td>at 0.7 bar</td><td>—</td></tr> </table>		at 0 bar life	—	at 0.7 bar	—										
at 0 bar life	—															
at 0.7 bar	—															

## Note

Maximum recommended operating pressure can be found on page 200.

Part No.	ID	OD	Length	Price		
<b>STANDARD TUBING</b>						
<b>Silicone Peroxide Tubing, 1.6 mm WT</b>						
MF0044	0.032" (0.8 mm)	0.158" (4.0 mm)	0.295" (7.5 mm)	\$ 48.14		
MF0035	0.063" (1.6 mm)	0.189" (4.8 mm)	0.295" (7.5 mm)	59.06		
MF0037	0.126" (3.2 mm)	0.252" (6.4 mm)	0.295" (7.5 mm)	72.62		
MF0045	0.189" (4.8 mm)	0.315" (8.0 mm)	0.295" (7.5 mm)	108.94		
MF0046	0.252" (6.4 mm)	0.378" (9.6 mm)	0.295" (7.5 mm)	96.19		
MF0047	0.315" (8.0 mm)	0.441" (11.2 mm)	0.295" (7.5 mm)	119.85		
<b>Silicone Peroxide Tubing, 2.4 mm WT</b>						
MF0288	0.189" (4.8 mm)	0.378" (9.6 mm)	0.295" (7.5 mm)	\$ 102.61		
MF0040	0.252" (6.4 mm)	0.441" (11.2 mm)	0.295" (7.5 mm)	131.68		
<b>Silicone Peroxide Tubing, 3.2 mm WT</b>						
MF0314	0.252" (6.4 mm)	0.504" (12.8 mm)	0.295" (7.5 mm)	\$ 211.55		
MF0041	0.374" (9.5 mm)	0.626" (15.9 mm)	0.295" (7.5 mm)	215.12		
MF0315	0.50" (12.7 mm)	0.752" (19.1 mm)	0.295" (7.5 mm)	354.04		
<b>Silicone Peroxide Tubing, 6 mm WT</b>						
MF0357	0.748" (19 mm)	1.22" (31 mm)	0.295" (7.5 mm)	\$ 474.81		
<b>STOPPER TUBING</b>						
Part No.	ID	OD	Color	Length	Qty.	Price
<b>Silicone Peroxide 2-Stop Tubing for CA Cassettes, 0.91 mm WT</b>						
SC0092	0.025" (0.64 mm)	2.46 mm	orange-white	15.75" (400 mm)	6-pk	\$ 69.87
<b>Silicone Peroxide 2-Stop Tubing for CA Cassettes, 0.84 mm WT</b>						
SC0093	0.03" (0.76 mm)	0.096" (2.44 mm)	black-black	15.75" (400 mm)	6-pk	\$ 69.87
SC0094	0.035" (0.89 mm)	0.101" (2.57 mm)	orange-orange	15.75" (400 mm)	6-pk	69.87
SC0095	0.04" (1.02 mm)	0.106" (2.7 mm)	white-white	15.75" (400 mm)	6-pk	69.87
SC0096	0.045" (1.14 mm)	0.111" (2.82 mm)	red-red	15.75" (400 mm)	6-pk	69.87
SC0097	0.051" (1.3 mm)	0.115" (2.93 mm)	grey-grey	15.75" (400 mm)	6-pk	69.87
SC0098	0.056" (1.42 mm)	0.12" (3.05 mm)	yellow-yellow	15.75" (400 mm)	6-pk	69.87
SC0099	0.06" (1.52 mm)	0.127" (3.24 mm)	yellow-blue	15.75" (400 mm)	6-pk	69.87
SC0100	0.025" (0.64 mm)	0.129" (3.28 mm)	blue-blue	15.75" (400 mm)	6-pk	69.87
SC0101	0.073" (1.85 mm)	0.139" (3.53 mm)	green-green	15.75" (400 mm)	6-pk	69.87
SC0102A	0.081" (2.06 mm)	0.147" (3.74 mm)	purple-purple	15.75" (400 mm)	6-pk	59.95
SC0103A	0.09" (2.29 mm)	0.152" (3.88 mm)	purple-black	15.75" (400 mm)	6-pk	59.95
SC0104	0.10" (2.54 mm)	0.169" (4.3 mm)	purple-orange	15.75" (400 mm)	6-pk	59.95
SC0105A	0.11" (2.79 mm)	0.176" (4.47 mm)	purple-white	15.75" (400 mm)	6-pk	59.95
<b>Silicone Peroxide 3-Stop Tubing for MS/CA Cassettes, 0.91 mm WT</b>						
SC0106	0.025" (0.64 mm)	0.097" (2.46 mm)	orange-white	15.75" (400 mm)	6-pk	\$ 78.95
<b>Silicone Peroxide 3-Stop Tubing for MS/CA Cassettes, 0.84 mm WT</b>						
SC0107	0.03" (0.76 mm)	0.096" (2.44 mm)	black-black	15.75" (400 mm)	6-pk	\$ 78.95
SC0108	0.035" (0.89 mm)	0.101" (2.57 mm)	orange-orange	15.75" (400 mm)	6-pk	78.95
SC0109	0.04" (1.02 mm)	0.106" (2.7 mm)	white-white	15.75" (400 mm)	6-pk	78.95
SC0110	0.045" (1.14 mm)	0.111" (2.82 mm)	red-red	15.75" (400 mm)	6-pk	78.95
SC0111	0.051" (1.3 mm)	0.115" (2.93 mm)	grey-grey	15.75" (400 mm)	6-pk	78.95
SC0112	0.056" (1.42 mm)	0.12" (3.05 mm)	yellow-yellow	15.75" (400 mm)	6-pk	78.95
SC0113	0.06" (1.52 mm)	0.127" (3.24 mm)	yellow-blue	15.75" (400 mm)	6-pk	78.95
SC0114	0.065" (1.65 mm)	0.129" (3.28 mm)	blue-blue	15.75" (400 mm)	6-pk	78.95
SC0115	0.073" (1.85 mm)	0.139" (3.53 mm)	green-green	15.75" (400 mm)	6-pk	78.95
SC0116	0.081" (2.06 mm)	0.147" (3.74 mm)	purple-purple	15.75" (400 mm)	6-pk	78.95
SC0117	0.09" (2.29 mm)	0.152" (3.88 mm)	purple-black	15.75" (400 mm)	6-pk	78.95
SC0118	0.10" (2.54 mm)	0.169" (4.3 mm)	purple-orange	15.75" (400 mm)	6-pk	78.95
SC0119	0.11" (2.79 mm)	0.176" (4.47 mm)	purple-white	15.75" (400 mm)	6-pk	64.33

## Fluran® F-5500-A Tubing

- ▶ Specially-formulated elastomer for use with strong acidic and basic solutions
- ▶ Very low gas permeability

Fluran tubing has been specially formulated for use in applications where strong acidic solutions or strong basic solutions are being used.

The material's very low gas permeability also makes this the choice material for applications where fluids can be transferred without being contaminated by atmospheric gases. Additionally, the low gas permeability and relative strength of this material make it a material of choice in vacuum based applications.



## Specifications

<b>Special Properties</b>	The special tubing for concentrated acids and corrosive solvents	
<b>Advantages</b>	<ul style="list-style-type: none"> <li>• High chemical resistance</li> <li>• Low gas permeability</li> <li>• Wide temperature range</li> </ul>	
<b>Limitations</b>	<ul style="list-style-type: none"> <li>• Limited service-life</li> </ul>	
<b>Physical Properties</b>	<ul style="list-style-type: none"> <li>• Fluoroelastomer</li> <li>• Firm, opaque, black</li> </ul>	
<b>Service Temperature Range</b>	-31 °C to +204 °C (-25 °F to + 400 °F)	
<b>Applications</b>	Acids	Excellent
	Alkaline solutions	Excellent
	Solvents	Limited
	Pressure	Not recommended
	Vacuum	Good
	Viscous media	Good
	Sterile media	Fair
<b>Complies with the Following Standards</b>	None	
<b>Sterilization</b>	Not recommended	
<b>Permeability</b>	$\frac{\text{Volume of gas [cm}^3\text{]} \times \text{wall thickness [mm]}}{\text{Area of tubing ID [cm}^2\text{]} \times \text{time [sec]} \times \text{pressure drop across tubing wall [cm Hg]}} \times 10^{-10}$	
	CO <sub>2</sub>	38
	O <sub>2</sub>	14
	N <sub>2</sub>	5
<b>Odor and taste</b>	—	
<b>Toxicity</b>	—	
<b>Tubing</b>	at 0 bar life	150
	at 0.7 bar	90

Part No.	ID	OD	Length	Price		
<b>STANDARD TUBING</b>						
<b>Fluran F-5500-A Tubing, 1.6 mm WT</b>						
MF0048	0.032" (0.8 mm)	0.158" (4.0 mm)	24.6' (7.5 m)	\$ 197.88		
MF0049A	0.063" (1.6 mm)	0.189" (4.8 mm)	24.6' (7.5 m)	207.88		
MF0051	0.126" (3.2 mm)	0.252" (6.4 mm)	24.6' (7.5 m)	274.18		
MF0322	0.189" (4.8 mm)	0.315" (8.0 mm)	24.6' (7.5 m)	345.88		
MF0052	0.252" (6.4 mm)	0.378" (9.6 mm)	24.6' (7.5 m)	392.19		
MF0053	0.315" (8.0 mm)	0.441" (11.2 mm)	24.6' (7.5 m)	501.13		
<b>Fluran F-5500-A Tubing, 2.4 mm WT</b>						
MF0050	0.189" (4.8 mm)	0.378" (9.6 mm)	24.6' (7.5 m)	\$ 536.52		
MF0054	0.252" (6.4 mm)	0.441" (11.2 mm)	24.6' (7.5 m)	632.71		
<b>Fluran F-5500-A Tubing, 3.2 mm WT</b>						
MF0323	0.252" (6.4 mm)	0.504" (12.8 mm)	24.6' (7.5 m)	\$ 917.80		
MF0055L	0.374" (9.5 mm)	0.626" (15.9 mm)	24.6' (7.5 m)	1,212.78		
<b>STOPPER TUBING</b>						
Part No.	ID	OD	Color	Length	Qty.	Price
<b>Fluran F-5500-A 2-Stop Tubing for CA Cassettes, 0.91 mm WT</b>						
SC0132	0.02" (0.51 mm)	0.093" (2.35 mm)	orange-yellow	7" (180 mm)	12-pk	\$ 89.86
SC0133	0.025" (0.64 mm)	0.098" (2.48 mm)	orange-white	7" (180 mm)	12-pk	92.62
SC0134	0.03" (0.76 mm)	0.102" (2.6 mm)	black-black	7" (180 mm)	12-pk	98.02
SC0135A	0.035" (0.89 mm)	0.108" (2.73 mm)	orange-orange	7" (180 mm)	12-pk	102.61
SC0136	0.04" (1.02 mm)	0.112" (2.86 mm)	white-white	7" (180 mm)	12-pk	106.18
SC0137	0.045" (1.14 mm)	0.117" (2.98 mm)	red-red	7" (180 mm)	12-pk	101.69
SC0138	0.05" (1.29 mm)	0.123" (3.13 mm)	grey-grey	7" (180 mm)	12-pk	105.26
SC0139	0.056" (1.42 mm)	0.128" (3.26 mm)	yellow-yellow	7" (180 mm)	12-pk	108.02
SC0140	0.06" (1.52 mm)	0.132" (3.36 mm)	yellow-blue	7" (180 mm)	12-pk	108.02
SC0141	0.065" (1.65 mm)	0.137" (3.49 mm)	blue-blue	7" (180 mm)	12-pk	113.53
SC0142	0.073" (1.85 mm)	0.145" (3.69 mm)	green-green	7" (180 mm)	12-pk	128.93
SC0143	0.081" (2.06 mm)	0.154" (3.9 mm)	purple-purple	7" (180 mm)	12-pk	132.50
SC0144	0.09" (2.29 mm)	0.163" (4.13 mm)	purple-black	7" (180 mm)	12-pk	138.01
SC0145	0.10" (2.54 mm)	0.172" (4.38 mm)	purple-orange	7" (180 mm)	12-pk	143.41
SC0146	0.11" (2.79 mm)	0.182" (4.63 mm)	purple-white	7" (180 mm)	12-pk	154.33
<b>Fluran F-5500-A 3-Stop Tubing for MS/CA Cassettes, 0.92 mm WT</b>						
SC0255A	0.02" (0.51 mm)	0.093" (2.35 mm)	orange-yellow	15.75" (400 mm)	12-pk	\$ 155.24
SC0256	0.025" (0.64 mm)	0.098" (2.48 mm)	orange-white	15.75" (400 mm)	12-pk	160.65
SC0257	0.03" (0.76 mm)	0.102" (2.6 mm)	black-black	15.75" (400 mm)	12-pk	166.16
SC0258	0.035" (0.89 mm)	0.108" (2.73 mm)	orange-orange	15.75" (400 mm)	12-pk	175.24
SC0259	0.04" (1.02 mm)	0.112" (2.86 mm)	white-white	15.75" (400 mm)	12-pk	181.56
SC0260	0.045" (1.14 mm)	0.117" (2.98 mm)	red-red	15.75" (400 mm)	12-pk	173.40
SC0261	0.05" (1.29 mm)	0.123" (3.13 mm)	grey-grey	15.75" (400 mm)	12-pk	179.72
SC0262	0.056" (1.42 mm)	0.128" (3.26 mm)	yellow-yellow	15.75" (400 mm)	12-pk	186.15
SC0263	0.06" (1.52 mm)	0.132" (3.36 mm)	yellow-blue	15.75" (400 mm)	12-pk	186.15
SC0264A	0.065" (1.65 mm)	0.137" (3.49 mm)	blue-blue	15.75" (400 mm)	12-pk	194.31
SC0265	0.073" (1.85 mm)	0.145" (3.69 mm)	green-green	15.75" (400 mm)	12-pk	218.79
SC0266	0.081" (2.06 mm)	0.154" (3.9 mm)	purple-purple	15.75" (400 mm)	12-pk	226.95
SC0267	0.09" (2.29 mm)	0.163" (4.13 mm)	purple-black	15.75" (400 mm)	12-pk	237.86
SC0268	0.10" (2.54 mm)	0.172" (4.38 mm)	purple-orange	15.75" (400 mm)	12-pk	246.94
SC0269	0.11" (2.79 mm)	0.182" (4.63 mm)	purple-white	15.75" (400 mm)	12-pk	260.51

## GORE™ Tubing for Special Applications

- ▶ For single channel tubing pumps
- ▶ Aggressive media
- ▶ High-pressure applications

### GORE Style 100 for High-Pressure Applications

- ▶ Extremely stable flow rates
- ▶ Variability in flow rate within 1% during total life time
- ▶ Virtually eliminates spallation (ensures continuously high purity in fluid transfer)
- ▶ For differential pressures up to 4 bar (60 psi)
- ▶ High burst strength up to 25 bar (360 psi)
- ▶ Exhibits 18 times the life of silicone rubber tubing



### GORE Style 100CR for Aggressive Media

- ▶ Extremely long life perfluorelastomer tubing
- ▶ Stable flow rates, variation less than 1% over tubing life
- ▶ Low solvent swell
- ▶ Extreme long service life
- ▶ Suitable for almost all aggressive chemicals, including organic solvents such as methylethylketone, toluene and acetone



## Specifications

#### GORE Style 100

Unique pressed composite material, not extruded, produced in clean room  
 Platinum cured Silicone and expanded PTFE  
 Available in bore sizes up to 50 mm ID  
 USP Class VI approved and classified nontoxic  
 Cited in FDA Type II Material Master File (MMF)  
 Operates at pressures up to 4 bar (60 psi)  
 In-line steam sterilizable

#### GORE Style 100CR

Fluoroelastomer tubing with expanded PTFE, not extruded, produced in clean room  
 1.6 to 16 mm ID  
 Permanently stable flow rates  
 USP Class VI approved  
 FDA approved for food contact  
 Operates at pressures up to 4 bar (60 psi)

## Application Note

#### GORE Style 100

In pharmaceutical, food and biotech processes

- Tangential flow filtration and other high-pressure applications
- Addition of anti-foam
- Long-term fermentation: continuous media recirculation over 75 days
- Transfer of live-cells from one container into another featuring excellent service life at low temperatures
- Ultra-filtration: high pressure stability allows higher system pressure and flow rate, which results in longer service life and fewer down-times due to tube exchanges

#### GORE Style 100CR

In electronic, medical, textile, industry

- Solvent-based ink for gravure printing
- Coating of glass bottles
- Chemical coating of plastic plates and film
- Chemical-based flow in waste water treatment
- Solvent-based coating of tablets
- Synthesis with high through-put
- Laboratory analysis or dispensing

## Related Products

- ▶ Gore Style 100 tubing can be used with the Flowmaster® dispensing pump found on page 97, which pumps up to 13 L/min.
- ▶ Gore Style 100CR tubing can be used for the REGLO Quick™ tubing pump found on page 96, which pumps up to 230 mL/min.

Part No.	ID	OD	Length	Price
<b>STANDARD TUBING</b>				
<b>GORE 100 Tubing, 0.8 mm WT</b>				
GX0015	0.11" (2.8 mm)	0.173" (4.4 mm)	1' (305 mm)	\$ 380.00
<b>GORE 100 Tubing, 1.6 mm WT</b>				
GX0018	0.063" (1.6 mm)	0.189" (4.8 mm)	1' (305 mm)	\$ 400.00
GX0004	0.126" (3.2 mm)	0.252" (6.4 mm)	1' (305 mm)	400.00
GX0014	0.189" (4.8 mm)	0.315" (8.0 mm)	1' (305 mm)	400.00
GX0013	0.315" (8.0 mm)	0.437" (11.1 mm)	1' (305 mm)	460.00
<b>GORE 100 Tubing, 2.4 mm WT</b>				
GX0005	0.189" (4.8 mm)	0.378" (9.6 mm)	1' (305 mm)	\$ 440.00
GX0006	0.252" (6.4 mm)	0.437" (11.1 mm)	1' (305 mm)	480.00
GX0002	0.315" (8.0 mm)	0.125" (12.7 mm)	1' (305 mm)	480.00
GX0017	0.374" (9.5 mm)	0.555" (14.1 mm)	1' (305 mm)	500.00
<b>GORE 100 Tubing, 3.2 mm WT</b>				
GX0007	0.252" (6.4 mm)	0.125" (12.7 mm)	2' (610 mm)	\$ 940.00
GX0001	0.374" (9.5 mm)	0.156" (15.9 mm)	2' (610 mm)	970.00
GX0003	0.125" (3.2 mm)	0.378" (9.6 mm)	2' (610 mm)	880.00
<b>GORE 100CR Tubing, 0.8 mm WT</b>				
GX0106	0.11" (2.8 mm)	0.173" (4.4 mm)	1' (305 mm)	\$ 900.00
<b>GORE 100CR Tubing, 1.6 mm WT</b>				
GX0008	0.063" (1.6 mm)	0.189" (4.8 mm)	1' (305 mm)	\$ 900.00
GX0011	0.126" (3.2 mm)	0.252" (6.4 mm)	1' (305 mm)	940.00
GX0010	0.189" (4.8 mm)	0.315" (8.0 mm)	1' (305 mm)	980.00
GX0012	0.252" (6.4 mm)	0.374" (9.5 mm)	1' (305 mm)	1,000.00
GX0009	0.315" (8.0 mm)	0.437" (11.1 mm)	1' (305 mm)	1,200.00
<b>GORE 100CR Tubing, 2.4 mm WT</b>				
GX0124	0.189" (4.8 mm)	0.374" (9.5 mm)	14" (355 mm)	\$ 1,200.00
GX0123	0.252" (6.4 mm)	0.437" (11.1 mm)	14" (355 mm)	1,250.00
GX0019	0.315" (8.0 mm)	0.125" (12.7 mm)	14" (355 mm)	1,250.00
<b>GORE 100CR Tubing, 3.2 mm WT</b>				
GX0131	0.374" (9.5 mm)	0.156" (15.9 mm)	2' (610 mm)	\$ 2,240.00